

Climate
Control

IMI Heimeier

Globo H



Ball valves

Gunmetal ball valve

Globo H

Globo H is used as a versatile shut-off element in pump hot-water heating systems. Thanks to the compact working radius of the operating toggle, the Globo H is the ideal valve for adjacent installation on distributors.

Key features

Body and ball made of corrosion-resistant gunmetal

Tubular body, ideal for continuous pipe insulation

Operating toggle outside the pipe insulation

Also available in Press version

Version with drain-off

DN 15-32 suitable for M106 actuator



Technical description

Application:

Heating and cooling systems.

Functions:

Shut-off:

Operating toggle which can be dismantled, made of shock resistant plastic with small projection. Since the toggle stop is hidden, there is no danger of injury.

Thermometer, retrofittable by simply replacing the red closing cap in the operating toggle, see accessories.

Draining (0615)

Dimensions:

Versions with internal thread from DN 15 to DN 50, with drain off from DN 15 to DN 50.

Versions with external/internal thread from DN 15 to DN 32. Flat-sealing external thread.

Versions with Viega press connection from DN 15 to DN 32.

Pressure class:

PN 16

Temperature:

Permitted operating temperature TB -10 °C - 120 °C (248 °F), with press connection or drain-off TB 110 °C (248 °F).

Material:

The body and the ball are made of corrosion-resistant gunmetal. Ball with smooth straight bore. Maintenance-free spindle sealing by two O-rings made of EPDM. Ball sealing from pure PTFE.

Media:

Water or neutral fluids, water-glycol mixtures (0-50%).

Insulation:

Heat insulation shells for versions with internal thread and press connection, consisting of two interlocked half shells, see accessories.

Actuators:

DN 15 - 32 suitable for M106 actuators. Article No. 230 V: 0600-00.700 24 V: 0600-01.700

Construction

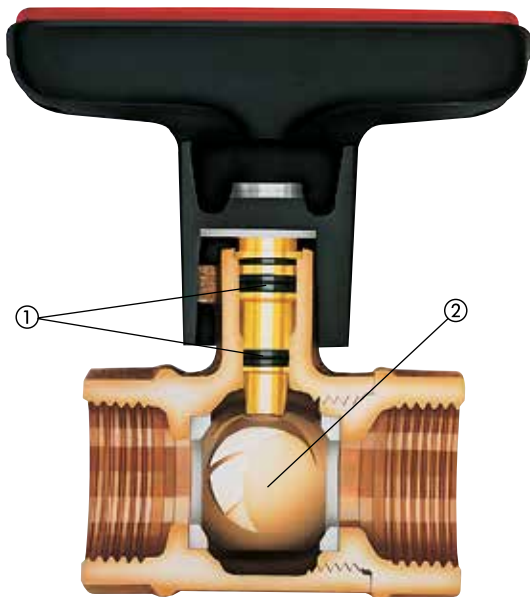

1. Spindle sealing with two O-ring
2. Solid gunmetal ball

Application

Globo H is used as a versatile shut-off element in pump hot-water heating systems.

Thanks to the compact working radius of the operating toggle, the Globo H is the ideal valve for adjacent installation on distributors.

The heating ball valve prevents heat loss as required by the respective energy saving ordinance. This requirement can be easily met by the use of heat insulation shells or with straight pipe insulation in view of the tube-shaped valve body. The operating toggle is located outside the heat insulation.

The version with external/internal thread makes it possible to make a detachable joint using suitable HEIMEIER screw connections with a threaded, soldered, welded or press nipple. The external thread is also suitable for the use of other flat sealing screw connections with direct clamping or slide joint.

Press connection

Globo ball valves with Viega press connection are suitable for copper pipes conforming to EN 1057 as well as Viega Sanpress stainless steel and Prestabo steel pipes.

All press connections as well as the valve bodies are made of corrosion-resistant, dezincification-free gunmetal.

Suitability press-fitting tools should be verified with the respective manufacturer.

We recommend using only Viega press-fitting jaws to make Viega press connections.

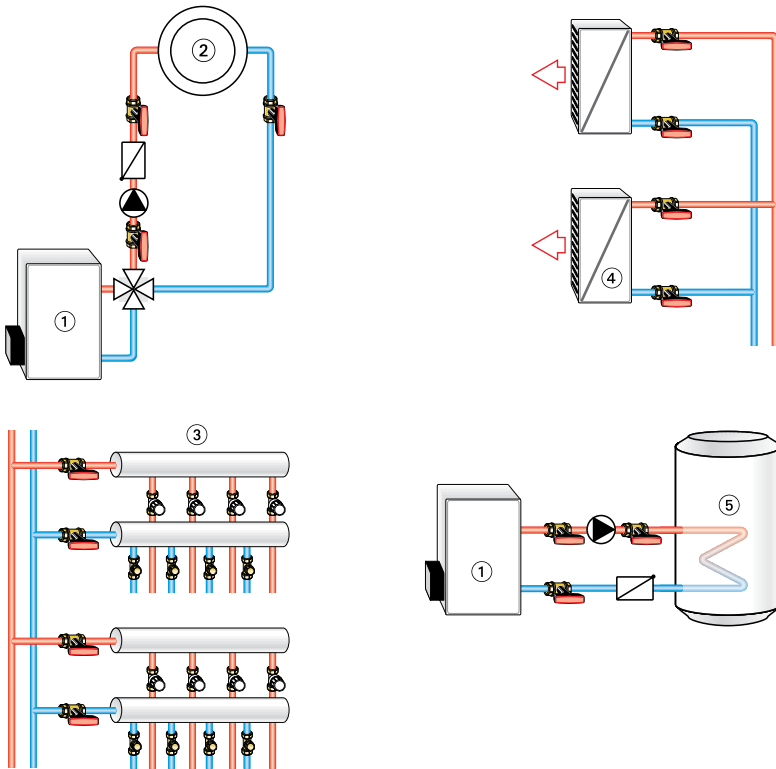
Sample application

1. Boiler
2. Heating circuit
3. Single storey manifold
4. Air heater
5. Hot water storage

Notes

To avoid damage and the formation of scale deposit in the hot-water heating system, the composition of the heat transfer medium should be in accordance with the VDI guideline 2035. For industrial and long-distance energy systems, see the applicable codes VdTÜV and 1466/AGFW FW 510. A heat transfer medium containing mineral oils, or any type of lubricant containing mineral oil can have extremely negative effects and usually lead to the disintegration of EPDM seals. When using nitrite-free frost and corrosion resistance solutions with an ethylene glycol base, pay close attention to the details outlined in the manufacturers' documentation, particularly concerning concentration and specific additives.

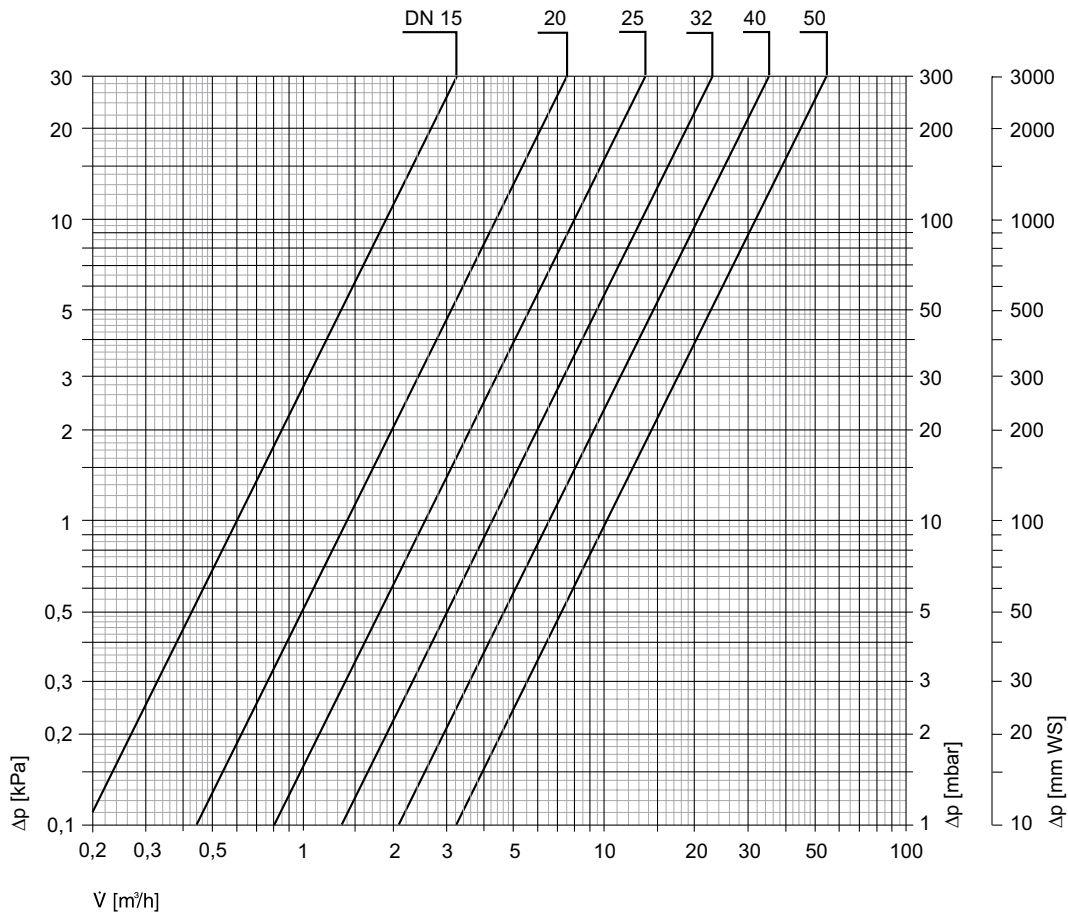
Diagram

Articles

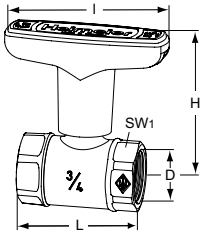

With internal thread

DN	D	L	I	H	Kvs	EAN	Article No
15	Rp1/2	56,0	81	69,0	6,0	4024052123414	0600-02.000
20	Rp3/4	58,5	81	72,0	14,0	4024052123513	0600-03.000
25	Rp1	67,5	81	74,5	25,0	4024052123711	0600-04.000
32	Rp1 1/4	76,5	81	78,0	42,0	4024052123810	0600-05.000
40	Rp1 1/2	87,5	120	111,5	65,0	4024052123919	0600-06.000
50	Rp2	101,5	120	116,5	100,0	4024052124114	0600-08.000

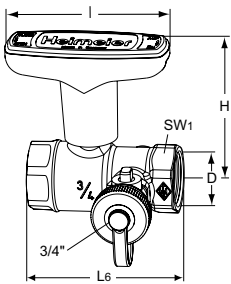

With internal thread

With drain-off

DN	D	L6	I	H	Kvs	EAN	Article No
15	Rp1/2	70	81	69,0	6,0	4024052973514	0615-02.000
20	Rp3/4	73	81	72,0	14,0	4024052973613	0615-03.000
25	Rp1	82	81	74,5	25,0	4024052973712	0615-04.000
32	Rp1 1/4	92,5	81	78,0	42,0	4024052973811	0615-05.000
40	Rp1 1/2	104	120	111,5	65,0	4024052973910	0615-06.000
50	Rp2	118	120	116,5	100,0	4024052974016	0615-08.000

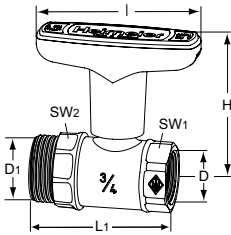

With external/internal thread

DN	D	D1	L1	I	H	Kvs	EAN	Article No
15	Rp1/2	G3/4	64,5	81	69,0	6,0	4024052516117	0601-02.000
20	Rp3/4	G1	69,0	81	72,0	14,0	4024052516216	0601-03.000
25	Rp1	G1 1/4	78,5	81	74,5	25,0	4024052516315	0601-04.000
32	Rp1 1/4	G1 1/2	89,5	81	78,0	42,0	4024052516445	0601-05.000

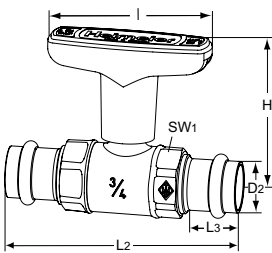

With Viega press connection with SC-Contur

DN	D2 [mm]	L2	L3	I	H	Kvs	EAN	Article No
15	15	110	22	81	69,0	6,0	4024052544318	0602-15.000
20	22	115	23	81	72,0	14,0	4024052544417	0602-22.000
25	28	129	23	81	74,5	25,0	4024052544554	0602-28.000
32	35	139	25	81	78,0	42,0	4024052544653	0602-35.000

SW1: 15 = 27 mm, DN 20 = 32 mm, DN 25 = 39 mm, DN 32 = 50 mm, DN 40 = 55 mm, DN 50 = 70 mm
 SW2: DN 15 = 29 mm, DN 20 = 35,5 mm, DN 25 = 44 mm, DN 32 = 51 mm

Accessories

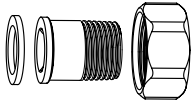

Screw connections with threaded nipple

Flat-sealing, for Globo with external thread.

Made of brass.

L [mm]	DN Globo		EAN	Article No
29,5	15	R1/2	4024052516612	0601-02.350
32,5	20	R3/4	4024052516810	0601-03.350
35	25	R1	4024052517015	0601-04.350
38,5	32	R1 1/4	4024052517213	0601-05.350

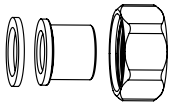

Screw connections with soldered nipple

Flat-sealing, for Globo with external thread.

Made of brass.

L [mm]	DN Globo	Ø	EAN	Article No
21	15	16	4024052517510	0601-16.352
25	20	22	4024052517718	0601-22.352
29	25	28	4024052517817	0601-28.352

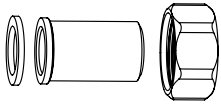

Screw connections with welded nipple

Flat-sealing, for Globo H with external thread

L [mm]	DN Globo	Ø	EAN	Article No
37	15	20,8	4024052516711	0601-02.353
42	20	26,8	4024052516919	0601-03.353
47	25	33,2	4024052517114	0601-04.353
47	32	41,8	4024052517312	0601-05.353

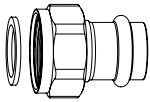

Screw connections with press nipple

Viega press connection with SC-Contur
Flat-sealing, for Globo with external thread.

Made of gunmetal.

L [mm]	DN Globo	Ø	EAN	Article No
34	15	15	4024052600519	0675-15.356
39	20	22	4024052600618	0675-22.356
44	32	35	4024052600816	0675-35.356

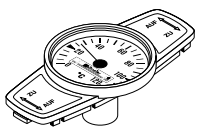

Thermometer

to replace by changing the red closing cap.

Temperatur range from 0 °C to 120 °C.

DN Globo	EAN	Article No
Red		
10-32	4024052423316	0600-00.380
40-50	4024052554812	0600-06.380
Blue		
10-32	4024052460618	0600-01.380
40-50	4024052554911	0600-07.380



Replacement handle

For	DN	EAN	Article No
Globo H, P, P-S, D	10-32	4024052123612	0600-03.520
Globo H, D	40-50	4024052124015	0600-06.520

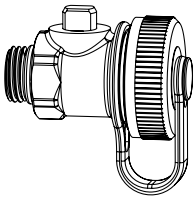

Filling and draining ball valve

Made of brass, with 3/4" hose connection and sealing cap with inserted seal. O-ring sealing thread connection G1/4. Max. operating temperature 110 °C.

EAN

Article No

4024052973019

0615-00.100

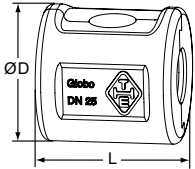

Heat insulating shell

Made of EPP
Fire class B2

DN	L	ØD	EAN	Article No
----	---	----	-----	------------

Globo

With female thread / press connection

15	74	62	4024052573813	0600-02.553
20	74	76	4024052573912	0600-03.553
25	83	84	4024052574018	0600-04.553
32	92	103	4024052574117	0600-05.553
40	106	115	4024052574216	0600-06.553
50	122	136	4024052574315	0600-08.553

With male / female thread

15	81	62	4024052574414	0601-02.553
20	90	76	4024052574513	0601-03.553
25	104	83	4024052574612	0601-04.553
32	112	103	4024052574711	0601-05.553

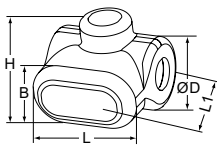

Heat insulating shell

for Globo H with drain-off.
Made of EPP
Fire class B2

DN	L	L1	ØD	H	B	EAN	Article No
----	---	----	----	---	---	-----	------------

15	92	94	61	78	56	4024052986217	0615-02.553
20	101	100	65	83	56	4024052986316	0615-03.553
25	112	117	86	95	63	4024052986415	0615-04.553
32	122	130	103	107	63	4024052986514	0615-05.553
40	134	145	118	143	71	4024052986613	0615-06.553
50	146	167	146	162	71	4024052986712	0615-08.553



The products, texts, photographs, graphics and diagrams in this document may be subject to alteration by IMI without prior notice or reasons being given. For the most up to date information about our products and specifications, please visit climatecontrol.imiplc.com