

Climate
Control

IMI TA

STAP



Differential pressure controllers

DN 15-50, adjustable set-point and shut-off function

STAP

STAP is a high-performing differential pressure controller that keeps the differential pressure over the load constant. This delivers accurate and stable modulating control, ensures less risk of noise from control valves, and results in easy balancing and commissioning. STAP's unrivalled accuracy and compact size make it particularly suitable for use on the secondary side of heating and cooling systems.



Key features

Pressure relief cone

Ensures accurate differential pressure control.

Measuring point with drain option

Simplifies the balancing procedure, and increases its accuracy.

Adjustable set-point and shut-off function

Delivers desired differential pressure ensuring accurate balancing. Shut-off function makes maintenance easy and straightforward.

Technical description

Application:

Heating and cooling systems.

Functions:

Differential pressure control
Adjustable Δp
Measuring point
Shut-off
Draining (accessory)

Dimensions:

DN 15-50

Pressure class:

PN 16

Max. differential pressure (Δp_V):

250 kPa

Setting range:

DN 15 LF: 5* - 25 kPa
DN 15 - 20: 5* - 25 kPa
DN 32 - 40: 10* - 40 kPa
DN 15 LF: 10* - 60 kPa
DN 15 - 25: 10* - 60 kPa
DN 32 - 50: 20* - 80 kPa

*) Delivery setting

LF = Low flow

Temperature:

Max. working temperature: 120°C
Min. working temperature: -20°C

Media:

Water or neutral fluids, water-glycol mixtures (0-57%).

Material:

Valve body: AMETAL®
Bonnet: AMETAL®
Cone: AMETAL®
Spindles: AMETAL®
O-rings: EPDM rubber
Membrane: HNBR rubber
Spring: Stainless steel
Spring support: AMETAL® and reinforced PPS
Handwheel: Polyamide

AMETAL® is the dezincification resistant alloy of IMI.

Marking:

Body: IMI or TA, PN 16/150, DN, inch size and flow direction arrow.
Bonnet: STAP, Δp_L 5-25, 10-40, 10-60 or 20-80.

Connection:

Internal thread according to ISO 228, thread length according to ISO 7-1.

Operating function



1. Setting ΔpL (3 mm allen key)
2. Shut-off
3. Connection capillary pipe
Venting
Connection measuring point STAP
4. Measuring point
5. Connection draining kit (accessory)

Measuring point

Remove the cover and then insert the probe through the self-sealed measuring point.

Measuring point STAP (accessory) can be connected to the venting if the STAD valve is out of reach for measuring of differential pressure.

Drain

Draining kit available as accessory. Can be connected during operation.

Installation

With ΔpV STAD **excluded** from the load.
(Best suited for Application examples 1, 3, 4 and 5)

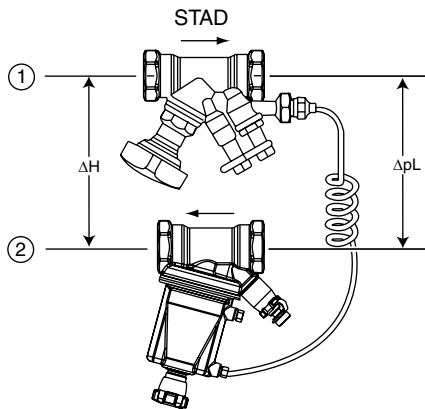

1. Inlet
2. Return

Note! The STAP must be placed in the return pipe and with correct flow direction.

To simplify installations in tight spaces, the bonnet can be detached.

When extending the capillary pipe, use e.g. 6 mm copper pipe and extension kit (accessory). **Note!** The supplied capillary pipe must be included.

With ΔpV STAD **included** in the load.
(Best suited for Application example 2)

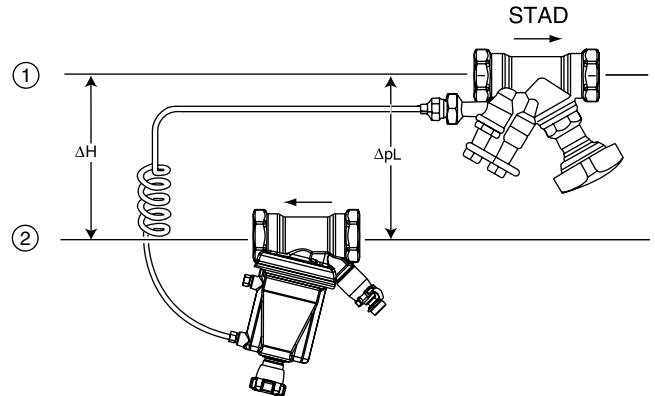

For further installation examples, see Handbook No 4 - Hydronic balancing with differential pressure controllers. STAD – see catalogue leaflet “STAD”.

Sizing

The diagram shows the lowest pressure drop required for the STAP valve to be within its working range at different flows.

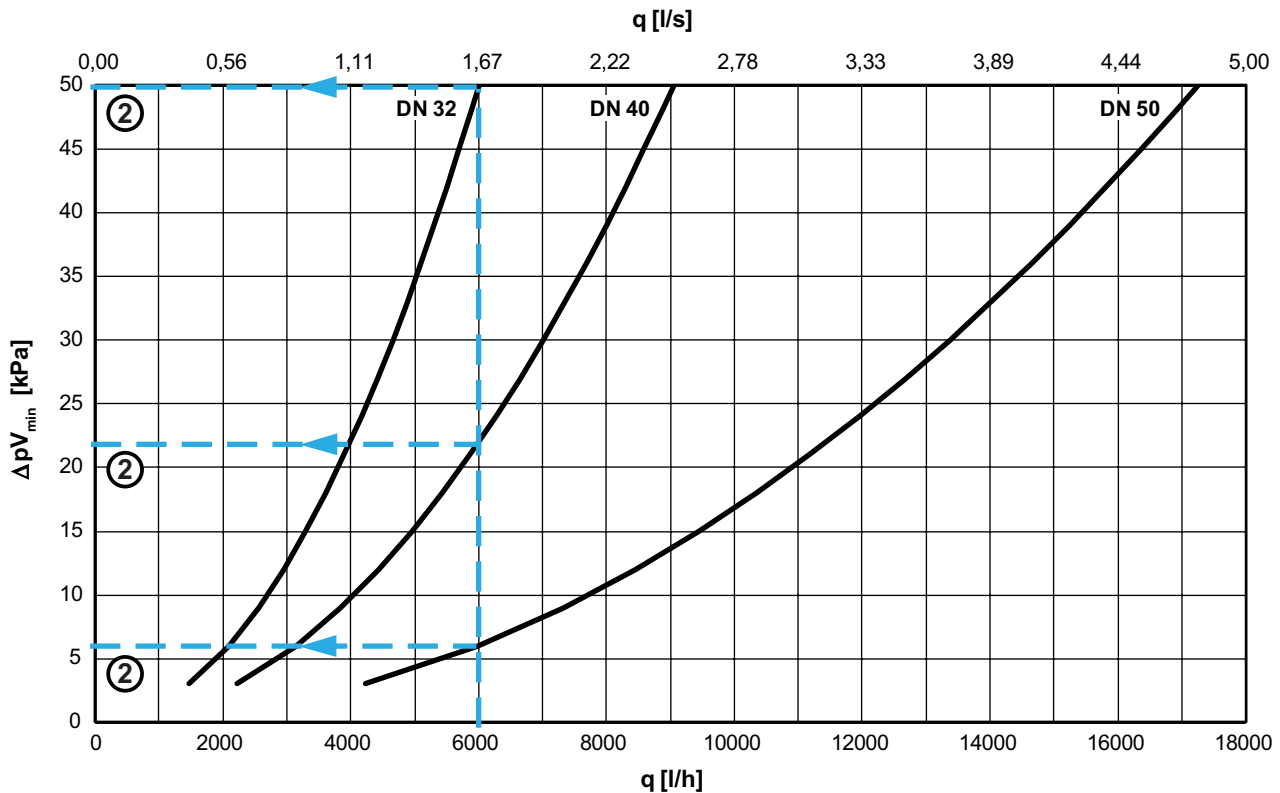
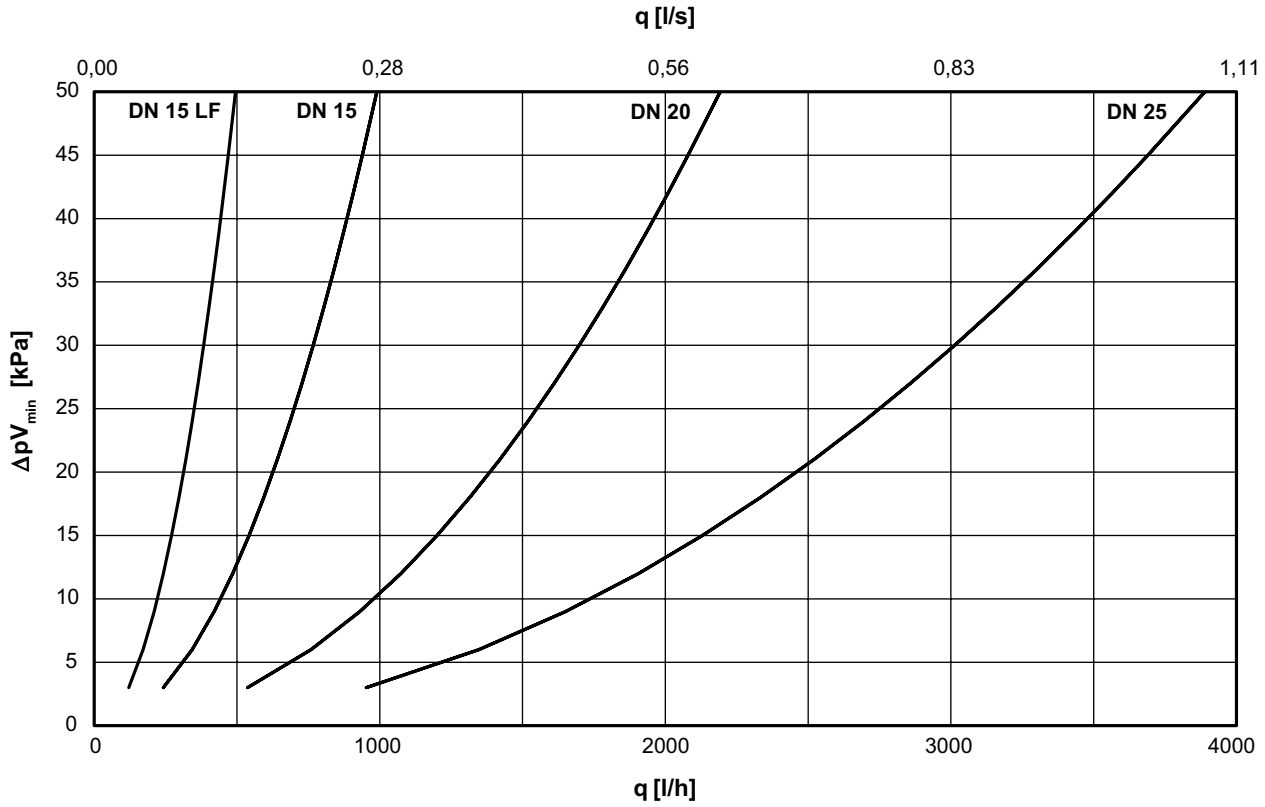

Example:

Design flow 6 000 l/h, $\Delta p_L = 23$ kPa and available differential pressure $\Delta H = 60$ kPa.

1. Design flow (q) 6 000 l/h.
2. Read the pressure drop ΔpV_{min} from the diagram.

DN 32 $\Delta pV_{min} = 50$ kPa
 DN 40 $\Delta pV_{min} = 22$ kPa
 DN 50 $\Delta pV_{min} = 6$ kPa

3. Check that the Δp_L is within the setting range for these sizes.
4. Calculate required available differential pressure ΔH_{min} .
 At 6 000 l/h and fully open STAD the pressure drop is, DN 32 = 18 kPa, DN 40 = 10 kPa and DN 50 = 3 kPa.

$$\Delta H_{min} = \Delta pV_{STAD} + \Delta pL + \Delta pV_{min}$$

DN 32: $\Delta H_{min} = 18 + 23 + 50 = 91$ kPa
 DN 40: $\Delta H_{min} = 10 + 23 + 22 = 55$ kPa
 DN 50: $\Delta H_{min} = 3 + 23 + 6 = 32$ kPa

5. In order to optimise the control function of the STAP select the smallest possible valve, in this case DN 40. (DN 32 is not suitable since $\Delta H_{min} = 91$ kPa and available differential pressure 60 kPa only).

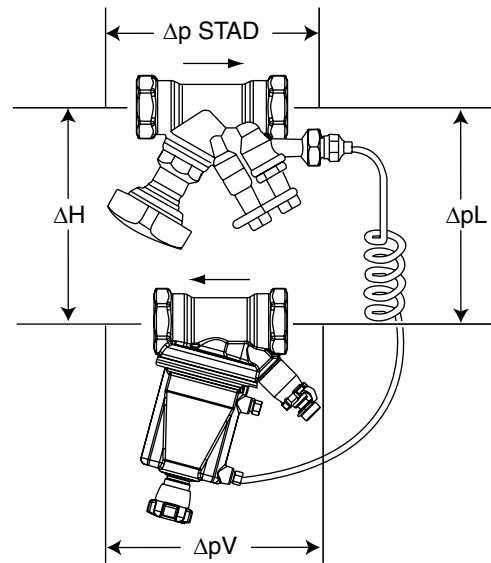

$$\Delta H = \Delta pV_{STAD} + \Delta pL + \Delta pV$$

IMI recommends the software HySelect for calculating the valve size. HySelect can be downloaded from climatecontrol.imiplc.com.

Working range

	Kv_{min}	Kv_{nom}	Kv_m	q_{max} [m³/h]
DN 15 LF	0,05	0,17	0,7	0,5
DN 15	0,07	1,0	1,4	1,0
DN 20	0,16	2,2	3,1	2,2
DN 25	0,28	3,8	5,5	3,9
DN 32	0,42	6,0	8,5	6,0
DN 40	0,64	9,0	12,8	9,1
DN 50	1,2	17,0	24,4	17,3

Kv_{min} = m³/h at a pressure drop of 1 bar and minimum opening corresponding to the p-band (+20% respectively +25%).
 Kv_{nom} = m³/h at a pressure drop of 1 bar and opening corresponding to the middle of the p-band (ΔpL_{nom}).
 Kv_m = m³/h at a pressure drop of 1 bar and maximum opening corresponding to the p-band (-20% respectively -25%).

Note! The flow in the circuit is determined by its resistance, i.e. Kv_C :

$$q_C = Kv_C \sqrt{\Delta p_l}$$

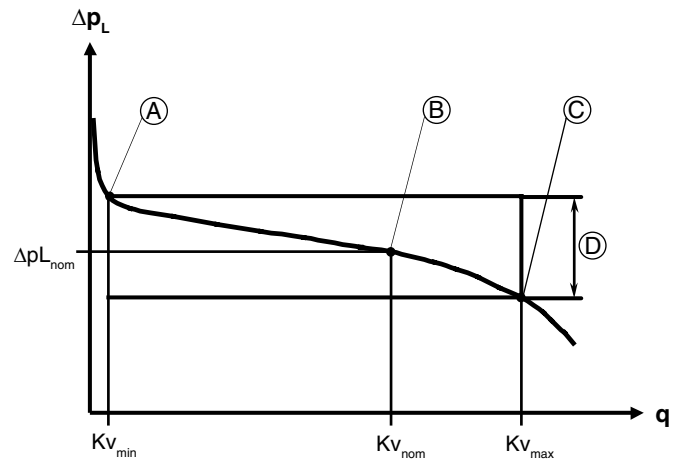

- A. Kv_{min}
- B. Kv_{nom} (Delivery setting)
- C. Kv_m
- D. Working range $\Delta pL_{nom} \pm 20\%$. STAP 5-25 and 10-40 kPa $\pm 25\%$.

Application examples

1. Stabilising the differential pressure across a circuit with presettable radiator valves

In plants equipped with presettable radiator valves (TRV), it is easy to get a good result. The presetting of the radiator valves limit the flow so that overflows do not occur. STAP limits the differential pressure and prevents noise.

- STAP stabilises Δp_L .
- The preset Kv-value of TRV limits the flow in each radiator.
- STAD is used for flow measuring, shut-off and connection of the capillary pipe.

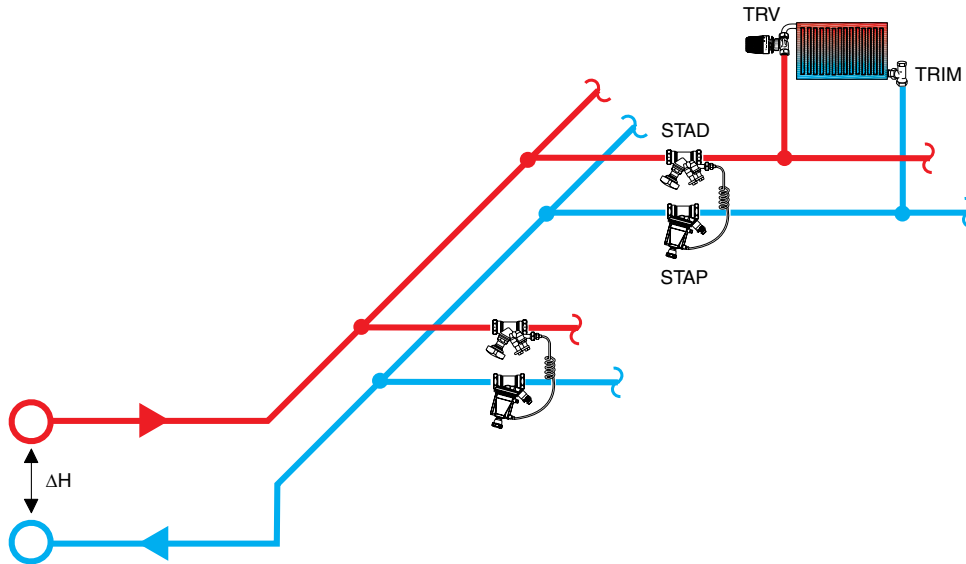

2. Stabilising the differential pressure across a circuit with non-presettable radiator valves

In plants equipped with non-presettable radiator valves it is not so easy to get an optimal result. Such radiator valves are common in older plants and will not limit the flow, which can be significantly too high in one or several circuits. Consequently, it is not enough that STAP limits the differential pressure across each circuit.

Letting STAP work together with STAD will solve the problem. STAD limits the flow to design value (using our balancing instrument to find the correct value). The correct distribution of the total flow between the radiators is however not achieved, but this solution can significantly improve a plant equipped with non-presettable radiator valves.

- STAP stabilises Δp_L .
- There is no presettable Kv-value on the radiator valve in order to limit the flow in each radiator.
- STAD limits the total flow in the circuit.

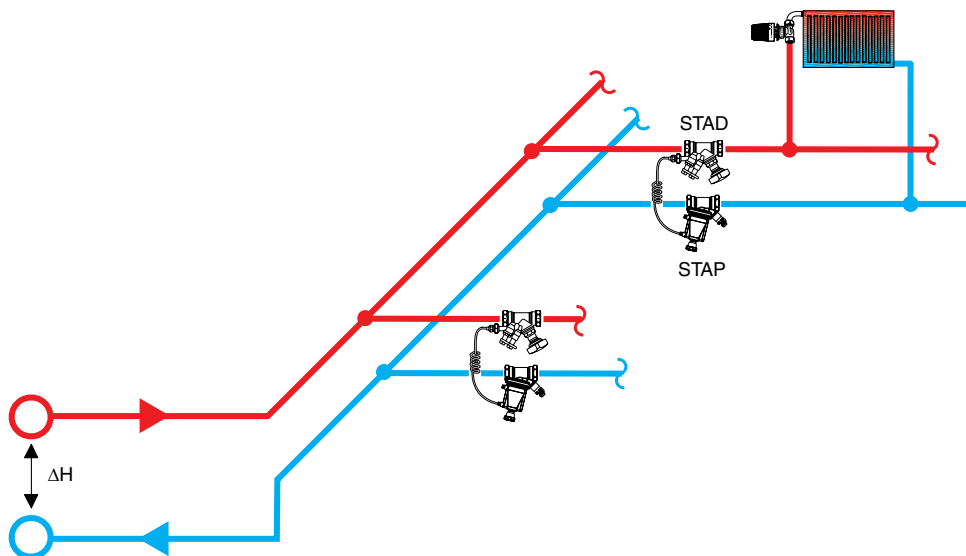

3. Stabilising the differential pressure across a circuit with control and balancing valves

When several small terminal units are close to one another, the differential pressure can be stabilised by using STAP in combination with STAD-1 across each circuit. STAD-2 for each terminal unit limits the flow and STAD-1 is used to measure the flow.

- STAP stabilises Δp_L .
- The set Kv-value in STAD-2 limits the flow in each terminal unit.
- STAD-1 is used for flow measuring, shut-off and connection of the capillary pipe.

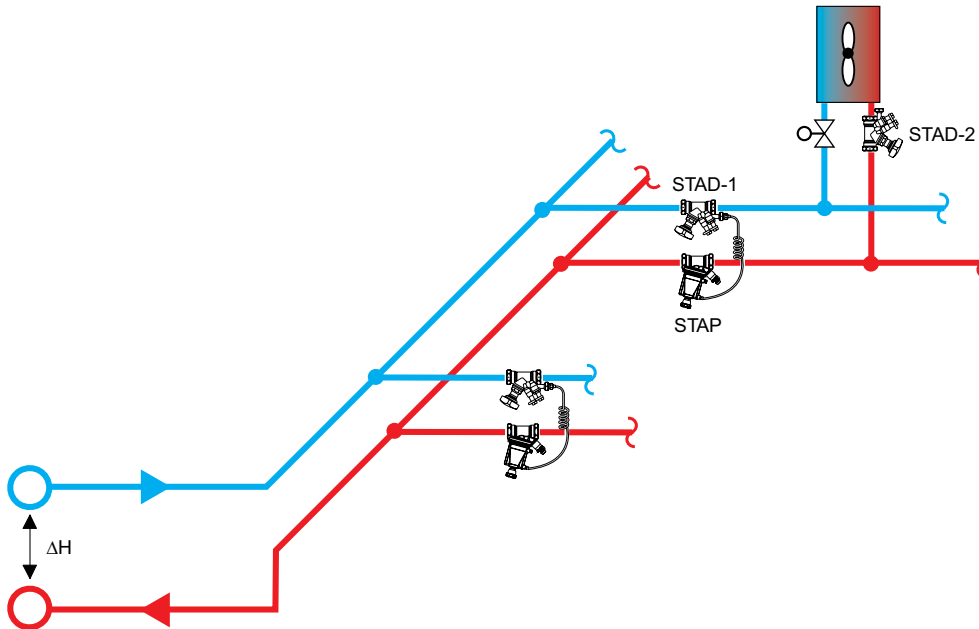

4. Stabilising the differential pressure across a riser with balancing valves (“Modular valve method”)

The “Modular valve method” is suitable when a plant is put into operation phase. Install one differential pressure controller on every riser, so that each STAP controls one module.

STAP keeps the differential pressure from the main pipe at a stable value out to the risers and circuits. STAD-2 downstream on the circuits guarantees that overflows do not occur. With STAP working as a modular valve, the whole plant does not need to be re-balanced when a new module is taken into operation. There is no need for balancing valves on the main pipes (except for diagnostic purposes), since the modular valves distribute the pressure out to the risers.

- STAP reduces a big and variable ΔH to a suitable and stable Δp_L .
- The set Kv-value in STAD-2 limits the flow in each circuit.
- STAD-1 is used for flow measuring, shut-off and connection of the capillary pipe.

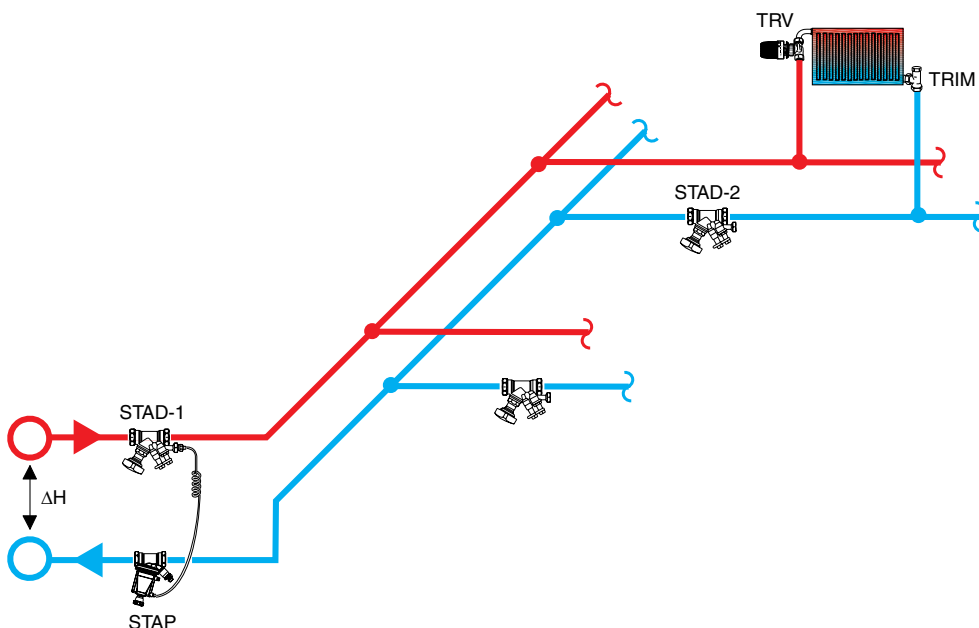

5. Keeping the differential pressure across a control valve constant

Depending on the design of the plant, the available differential pressure across some circuits can vary significantly with the load. To keep the correct control valve characteristic in such a case, the differential pressure across the control valves can be kept almost constant by a STAP connected directly across each control valve. The control valve will not be over-sized and the authority is and will remain close to 1.

If all control valves are combined with STAP, there is no need for other balancing valves, except for diagnostic purposes.

- STAP keeps Δp across the control valve constant, giving a valve authority ~ 1 .
- The Kvs of the control valve and the chosen Δp gives the design flow.
- STAD-1 is used for flow measuring, shut-off and connection of the capillary pipe.

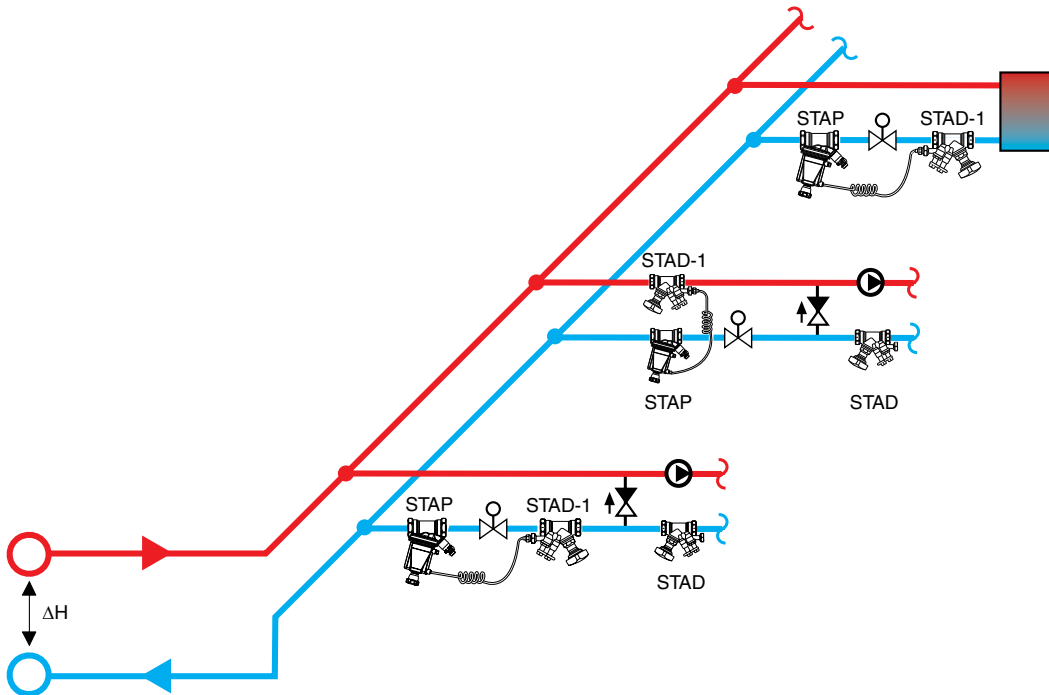

Sizing the control valve

A control valve should give a flow of 1000 l/h at a ΔH varying between 55 and 160 kPa.

- With a differential pressure of 10 kPa over the control valve, the Kvs will be 3,16.
- Control valves are normally available with Kvs -values according to the series 0,25 – 0,4 – 0,63 – 1,0 – 1,6 – 2,5 – 4,0 – 6,3 ...
- Choose $Kvs=2,5$, which will give a Δp of 16 kPa. Since the STAP guarantees a high control valve authority, a low pressure drop over the control can be chosen. Therefore, choose the biggest Kvs value that gives a Δp above the minimum set point of STAP (i.e. 5, 10 or 20 kPa depending on size and type).
- Adjust STAP to give $\Delta p_L = 16$ kPa. Check the flow with IMI TA balancing instrument over STAD-1 and with the control valve fully open.

Articles

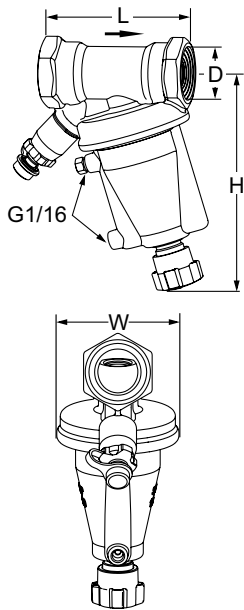

Internal threads

1 m capillary pipe and transition nipples G1/2 and G3/4 are included.

DN	D	L	H	W	Kv _m	q _{max} [m ³ /h]	Kg	EAN	Article No
5-25 kPa									
15* LF	G1/2	84	137	72	0,7	0,5	1,1	5902276821271	52 264-115
15*	G1/2	84	137	72	1,4	1,0	1,1	7318793946607	52 265-115
20*	G3/4	91	139	72	3,1	2,2	1,2	7318793946706	52 265-120
10-40 kPa									
32	G1 1/4	133	179	110	8,5	6,0	2,6	7318793790002	52 265-132
40	G1 1/2	135	181	110	12,8	9,1	2,9	7318793790101	52 265-140
10-60 kPa									
15* LF	G1/2	84	137	72	0,7	0,5	1,1	5902276821264	52 264-015
15*	G1/2	84	137	72	1,4	1,0	1,1	7318793623201	52 265-015
20*	G3/4	91	139	72	3,1	2,2	1,2	7318793623300	52 265-020
25	G1	93	141	72	5,5	3,9	1,3	7318793623409	52 265-025
20-80 kPa									
32	G1 1/4	133	179	110	8,5	6,0	2,6	7318793623805	52 265-032
40	G1 1/2	135	181	110	12,8	9,1	2,9	7318793623904	52 265-040
50	G2	137	187	110	24,4	17,3	3,5	7318793624000	52 265-050

→ = Flow direction

LF = Low flow

Kv_m = m³/h at a pressure drop of 1 bar and maximum opening corresponding to the p-band (-20% respectively -25%).

*) Can be connected to smooth pipes by KOMBI compression coupling. See accessories or catalogue leaflet KOMBI.

G = Thread according to ISO 228. Thread length according to ISO 7-1.

STAP/STAD

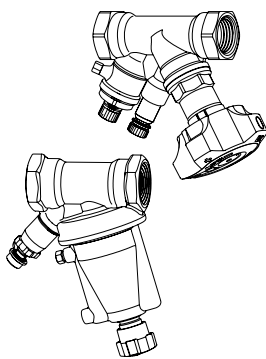

STAP/STAD package

For more information on STAD see separate catalogue leaflet

STAP DN	STAD DN	EAN	Article No
5-25 kPa			
15 LF	10	5902276822315	52 864-301
15 LF	15	5902276822322	52 864-302
15	15	7318794042001	52 865-101
20	20	7318794042100	52 865-102
10-40 kPa			
32	32	7318794042209	52 865-103
40	40	7318794042308	52 865-104
10-60 kPa			
15 LF	10	5902276822339	52 864-111
15 LF	15	5902276822346	52 864-112
15	10	7318794041301	52 865-001
15	15	7318794041400	52 865-002
20	20	7318794041509	52 865-003
25	25	7318794041608	52 865-004
20-80 kPa			
32	32	7318794041707	52 865-005
40	40	7318794041806	52 865-006
50	50	7318794041905	52 865-007

LF = Low flow

Accessories

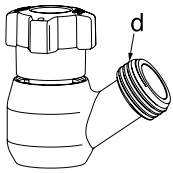

Draining kit STAP

d	EAN	Article No
G1/2	7318793660404	52 265-201
G3/4	7318793660503	52 265-202

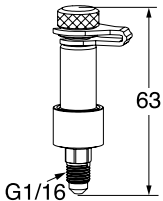

Measuring point STAP

EAN	Article No
7318793660602	52 265-205

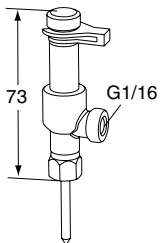

Measuring point, two-way

For connection of capillary pipe while permitting simultaneous use of our balancing instrument.

EAN	Article No
7318793784100	52 179-200

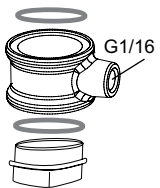

Connection sleeve kit for capillary pipe

For use on STAD or STS. Replacement of existing draining.

EAN	Article No
7318794027800	52 265-216

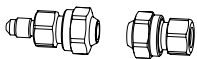

Extension kit for capillary pipe

Complete with connections for 6 mm pipe

EAN	Article No
7318793781505	52 265-212

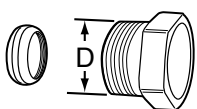

Compression connection KOMBI

See catalogue leaflet KOMBI.

D	Pipe Ø	EAN	Article No
G1/2	10	7318792874901	53 235-109
G1/2	12	7318792875007	53 235-111
G1/2	14	7318792875106	53 235-112
G1/2	15	7318792875205	53 235-113
G1/2	16	7318792875304	53 235-114
G3/4	15	7318792875403	53 235-117
G3/4	18	7318792875601	53 235-121
G3/4	22	7318792875700	53 235-123

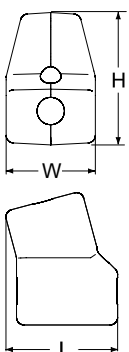

Insulation STAP

For heating/cooling

Material: EPP

Fire class: B2 (DIN 4102)

Max working temperature: 120°C (intermittent 140°C)

Min working temperature: 12°C, -8°C at sealed joints.

For DN	L	H	W	EAN	Article No
15-25	145	172	116	7318793658906	52 265-225
32-50	191	234	154	7318793659002	52 265-250

Spare parts

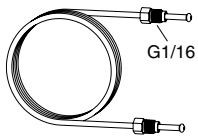

Capillary pipe

L	EAN	Article No
1 m	7318793661500	52 265-301

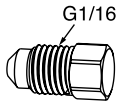

Plug Venting

EAN	Article No
7318793661609	52 265-302

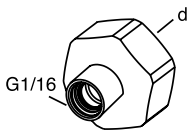

Transition nipple

For capillary pipe with G1/16 connection.

d	EAN	Article No
G1/2	7318793660206	52 179-981
G3/4	7318793660305	52 179-986



The products, texts, photographs, graphics and diagrams in this document may be subject to alteration by IMI without prior notice or reasons being given. For the most up to date information about our products and specifications, please visit climatecontrol.imiplc.com.