

Climate
Control

IMI TA

TA-BVS 140/143



Balancing valves
Of steel

TA-BVS 140/143

A steel balancing valve that delivers accurate hydronic performance in a wide range of applications. The TA-BVS 140/143 are available with flanges or welding ends and is ideal for use on heating and cooling systems (HVAC/R) and other oxygen-free water applications.

Key features

Easy to operate

DN 15-50 are equipped with a precision control handwheel and allows the balancing valve to be locked to a set value, making the valve easy to adjust. DN 65-150 are equipped with a removable handle that ensures accurate and straightforward balancing. DN 200 and up are equipped with a manual gear.

Measuring points

For simple, accurate balancing.

Steel body

Fully welded body construction is light weight, easy to insulate and maintenance free.



Technical description

Application:

Heating and cooling systems

Functions:

Balancing
Pre-setting
Measuring (DN 15-300)
Shut-off

Dimensions:

DN 15-300, DN 400

Pressure class:

Valve body:

DN 15-300, DN 400: PN 25

Flanges:

DN 15-50: PN 25 (also fit PN 10, 16 and 40 flanges)

DN 65-300, DN 400: PN 16 (PN 10, 25 and 40 on request)

Temperature:

DN 15-50:

Max. working temperature: 120°C

Min. working temperature: -20°C

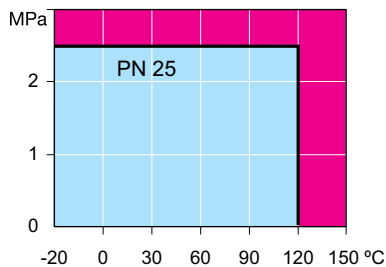

Note: Not for steam.

Below -20°C contact IMI.

DN 65 and up:

Max. working temperature: 200°C

Min. working temperature: -20°C

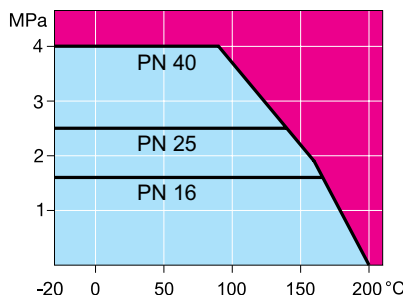

Note: Not for steam.

Below -20°C contact IMI.

Media:

Clean media e.g. oxygen-free water or glycol.

Leakage rate:

A (EN 12266-1)

Material:

Valve body: Steel P235GH (EN 1.0345).

Ball: Stainless steel X5CrNi18-10 (EN 1.4301), DN 15-50 also PA-GF30.

Ball seal: Hardened PTFE+GF.

Spindle: Stainless steel X8CrNiS18-9 (EN 1.4305).

Spindle seal: FPM.

Measuring points (DN 15-300): Brass.

Handwheel (DN 15-50): PA-GF50.

Handle (DN 65-150): Zinc-plated steel.

DN 200-300, DN 400 with manual gear.

Marking:

Body and flanges: Traceability No.

Label on body: IMI TA, DN, PN, CE 0496* (DN 32-400), material, max. temperature, product No and flow direction arrow.

*) Notified body.

Flanges:

EN 1092-1, ISO 7005-1.

Construction

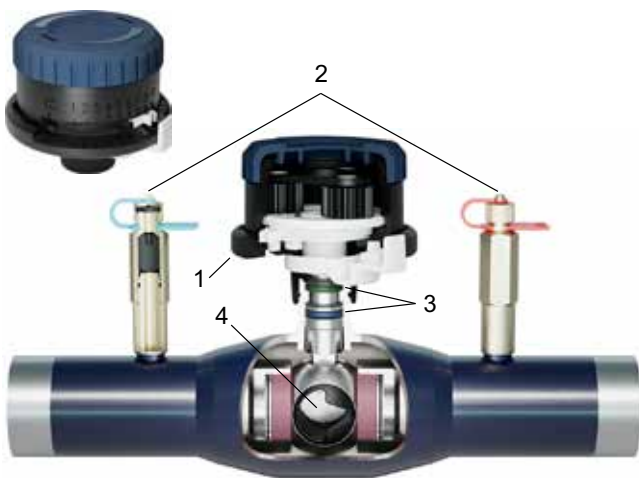

1. Precision control handwheel
2. Self-sealed measuring points
3. Two O-rings. The upper can be replaced during operation.
4. Ball with W-port flow tube. Equal percentage valve characteristic.

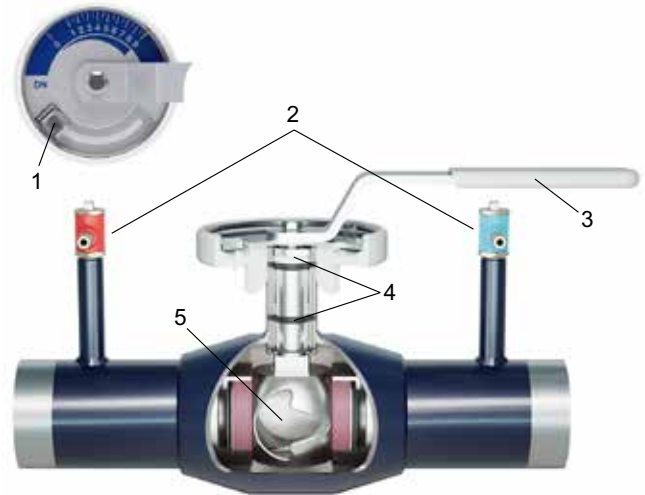

1. Locking screw
2. Measuring points
3. Removable handle
4. Two O-rings. The upper can be replaced during operation.
5. Ball with W-port flow tube. Equal percentage valve characteristic.

Measuring accuracy

Deviation of flow at different settings

The curve is valid for valves with normal pipe fittings. Try also to avoid mounting taps and pumps, immediately before the valve.

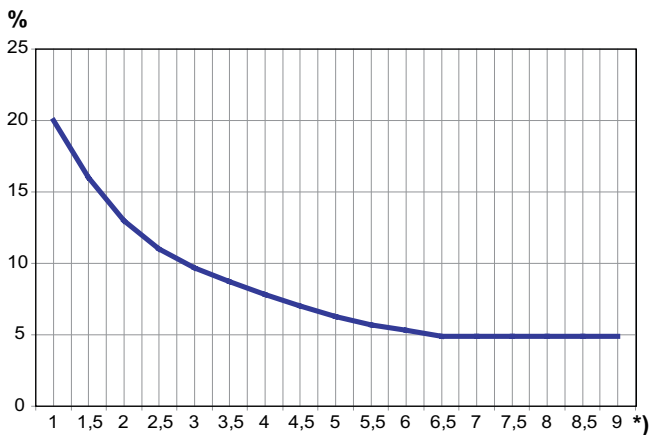

*) Setting.

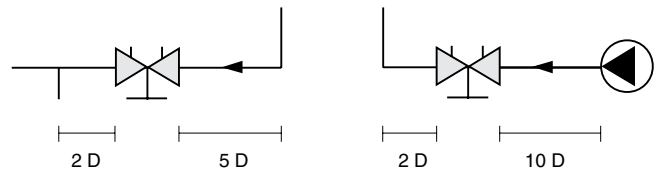

D = Valve DN

Sizing

When Δp and the design flow are known, use the formula to calculate the Kv value or use the diagram.

$$K_v = 0,01 \frac{q}{\sqrt{\Delta p}} \quad q \text{ l/h, } \Delta p \text{ kPa}$$

$$K_v = 36 \frac{q}{\sqrt{\Delta p}} \quad q \text{ l/s, } \Delta p \text{ kPa}$$

Kv values

NOTE: New Kv values for valves DN 15-50 equipped with precision control handwheel. In softwares (HySelect, HyTools) and balancing instrument (TA-SCOPE) the TA-BVS, DN 15-50, is named TA-BVS*.

Kv values for DN 65 and up remain the same.

Setting	DN 15	DN 20	DN 25	DN 32	DN 40	DN 50	DN 65	DN 80	DN 100	DN 125	DN 150	DN 200	DN 250	DN 300	DN 400
1	-	0,04	0,19	0,22	0,48	0,71	2,52	3,42	6,48	6,84	13,7	19,7	35,0	54,4	162
1,5	0,04	0,07	0,35	0,41	0,60	1,29	3,64	5,37	9,47	13,3	20,2	20,2	51,2	80,0	242
2	0,06	0,12	0,56	0,61	0,82	2,09	4,75	7,31	12,5	18,0	26,6	38,4	66,5	105	362
2,5	0,11	0,20	0,77	0,85	1,29	3,10	6,34	10,2	16,3	24,3	35,5	51,1	90,0	142	429
3	0,18	0,30	1,10	1,21	1,84	4,02	7,92	13,1	20,1	30,6	44,3	63,8	110	176	552
3,5	0,25	0,45	1,41	1,67	2,47	5,11	9,78	16,1	24,5	37,8	55,1	79,3	140	220	665
4	0,33	0,63	1,80	2,17	3,29	6,48	11,6	19,1	28,8	45,0	65,9	95,0	165	260	810
4,5	0,45	0,83	2,29	2,68	4,19	8,20	14,2	23,3	35,8	55,3	84,1	121	215	336	970
5	0,59	1,02	2,86	3,46	5,44	10,4	16,7	27,5	42,8	65,5	102	147	260	408	1194
5,5	0,72	1,51	3,60	4,50	7,05	13,0	20,9	33,2	51,8	81,7	127	183	325	510	1420
6	0,90	2,10	4,63	5,89	9,09	16,3	25,2	38,9	60,8	97,9	152	219	380	600	1744
6,5	1,13	2,72	5,62	7,35	11,5	20,4	29,5	46,3	75,4	122	197	282	500	785	2110
7	1,42	3,52	6,77	9,14	14,0	24,5	33,8	53,6	90,0	146	241	325	576	950	2636
7,5	1,70	4,39	8,35	11,0	17,1	29,3	39,8	64,6	113	177	290	417	740	1156	3380
8	2,04	5,40	9,96	12,9	20,2	34,1	45,7	75,6	137	209	338	486	866	1353	4191
8,5	2,32	6,66	11,8	15,0	22,8	37,1	53,5	91,8	169	251	400	576	1020	1594	5545
9	2,61	8,18	13,8	17,3	25,1	39,7	61,2	108	216	294	461	660	1170	1840	7159

Old Kv values for DN 15-50 valves equipped with **handle**.

Setting	DN 15/20	DN 25	DN 32	DN 40	DN 50
1	-	-	0,39	0,60	1,26
1,5	-	0,35	0,57	1,01	1,80
2	0,14	0,49	0,83	1,48	2,70
2,5	0,28	0,99	1,08	2,02	3,55
3	0,42	1,36	1,44	2,70	4,39
3,5	0,61	1,66	1,80	3,24	5,61
4	0,80	2,00	2,30	3,96	6,84
4,5	1,02	2,40	2,74	4,86	8,34
5	1,24	3,00	3,42	5,98	9,83
5,5	1,64	3,50	4,21	7,18	11,9
6	2,04	4,50	5,11	8,57	14,0
6,5	2,64	5,10	5,97	10,2	16,9
7	3,24	6,70	7,27	12,3	19,8
7,5	3,84	7,30	8,64	14,4	23,4
8	4,45	9,30	10,1	17,6	27,0
8,5	5,04	10,0	11,5	20,9	30,6
9	5,83	12,6	13,1	22,6	34,2

Setting

DN 15-50

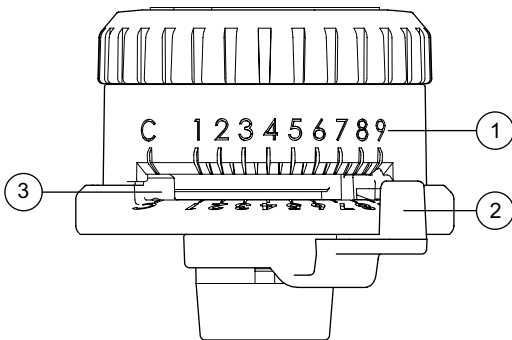

1. Set the limiter (2) to the specified preset value (1).
2. Adjust the hand (3) so it rests on the edge of the limiter (2)

Note: If preset value C is selected, the valve will function as a shut-off valve.

DN 65-150

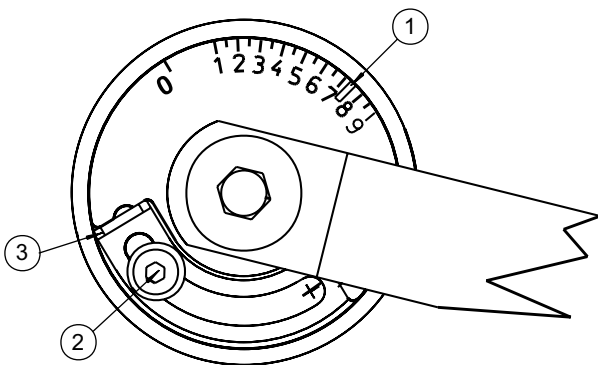

1. Adjust to the desired position (1).
2. Open the locking screw of the limiter (2).
3. Move the limiter against the edge of the scale plate (3).
4. Tighten the locking screw of the limiter (2).

DN 200-300, DN 400

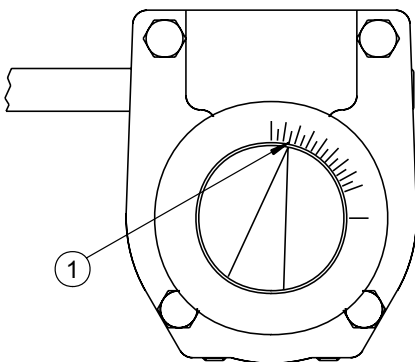

1. Adjust to the desired position (1).

Diagram

DN 15

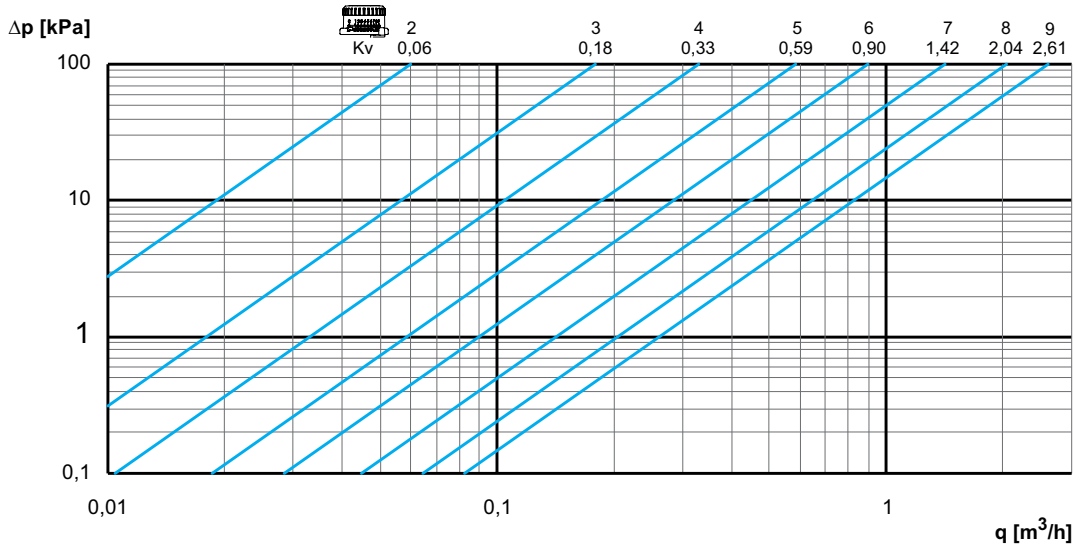

DN 20

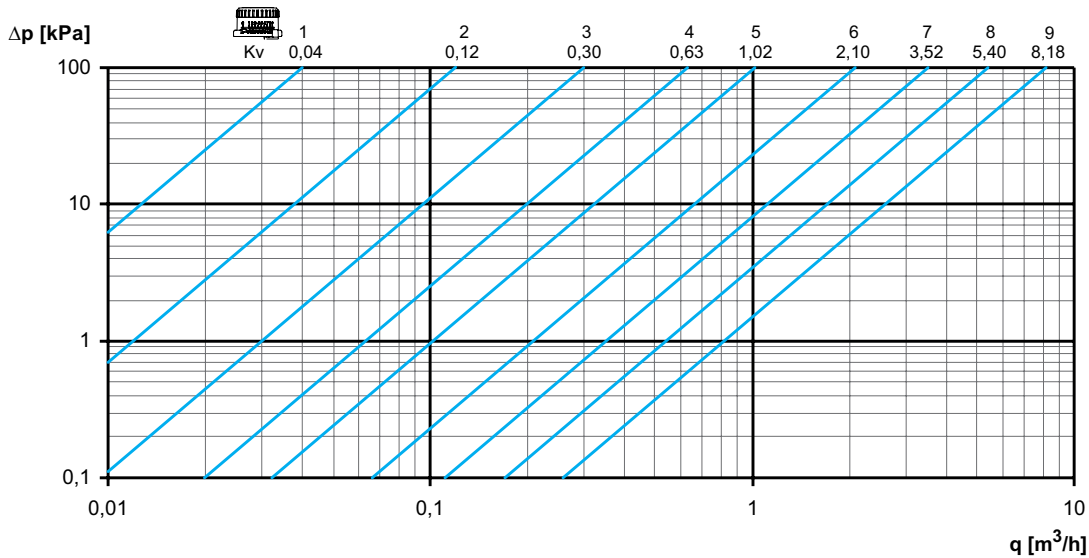

NOTE: New Kv values for valves DN 15-50 equipped with precision control handwheel. In softwares (HySelect, HyTools) and balancing instrument (TA-SCOPE) the TA-BVS, DN 15-50, is named TA-BVS*.
Kv values for DN 65 and up remain the same.

DN 25

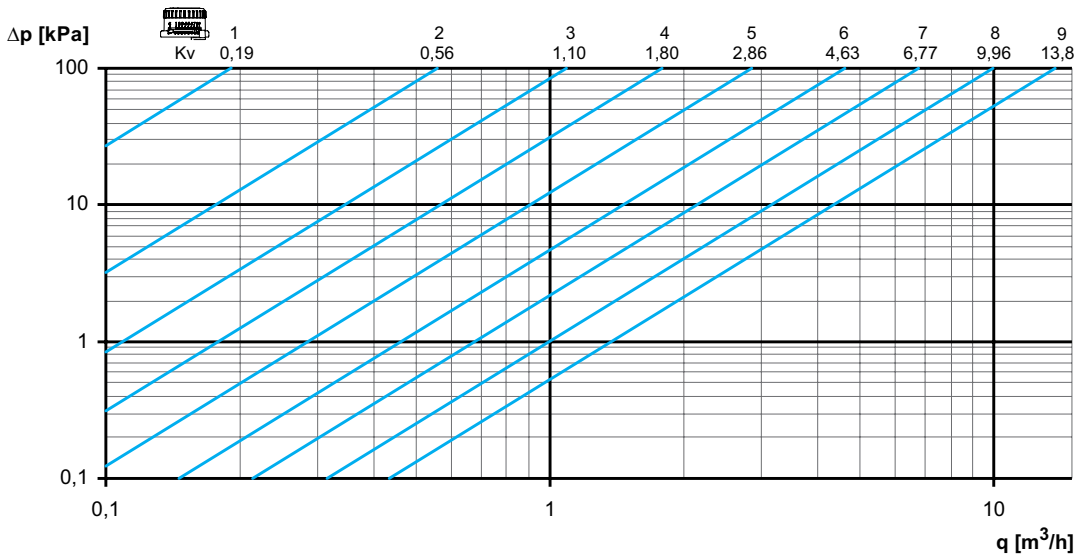

DN 32

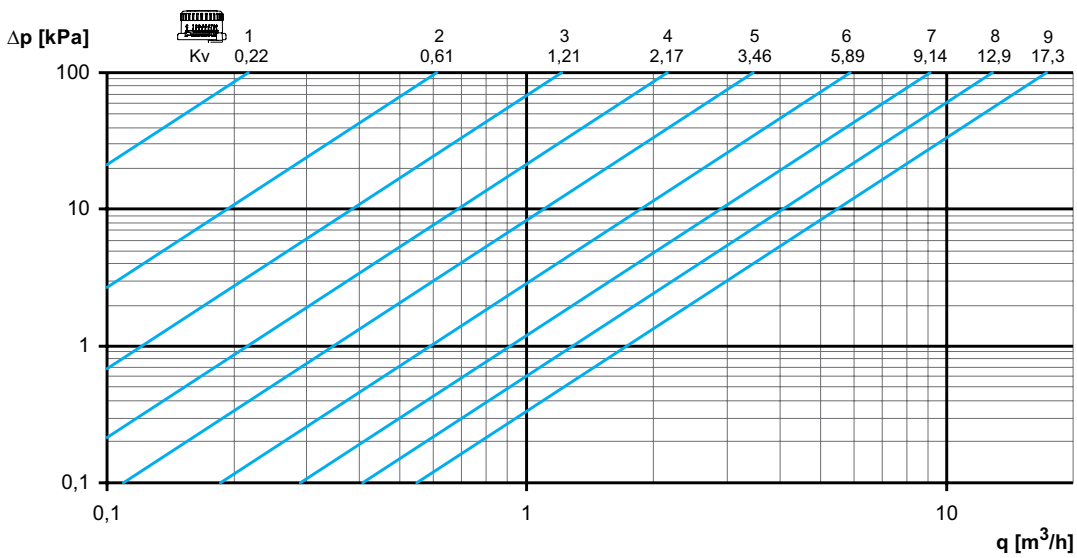

NOTE: New Kv values for valves DN 15-50 equipped with precision control handwheel. In softwares (HySelect, HyTools) and balancing instrument (TA-SCOPE) the TA-BVS, DN 15-50, is named TA-BVS*. Kv values for DN 65 and up remain the same.

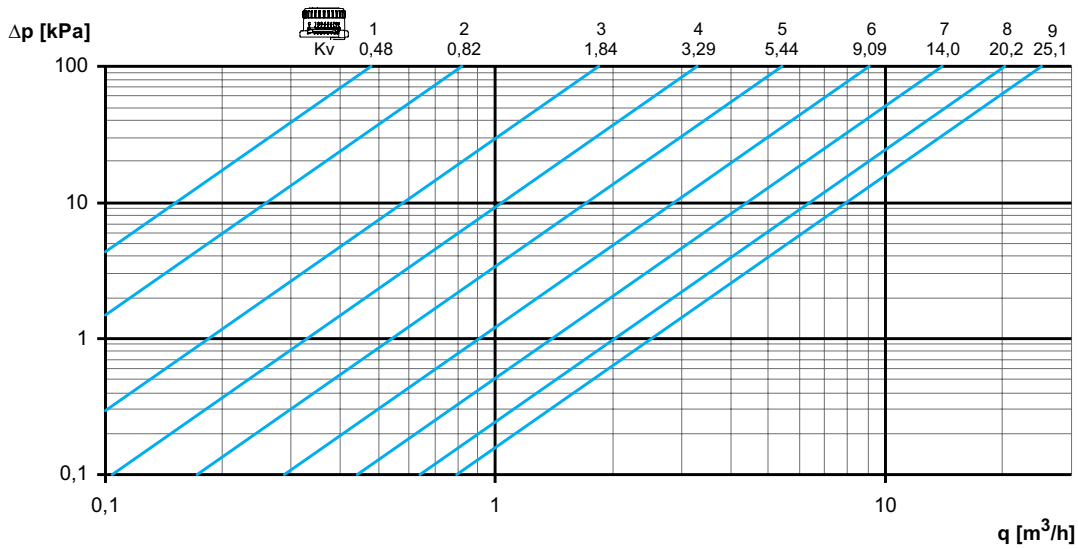
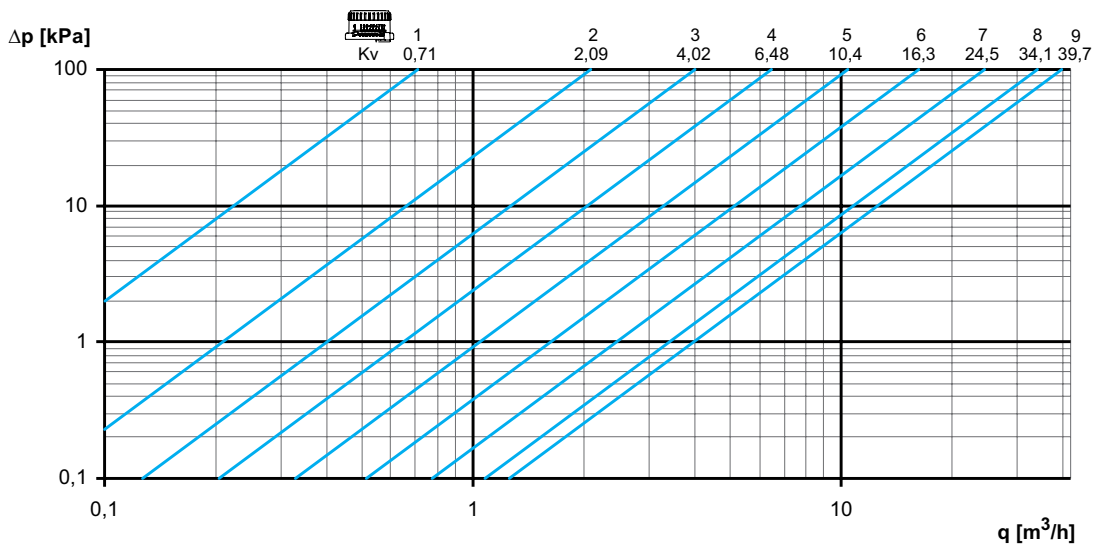
DN 40

DN 50

NOTE: New Kv values for valves DN 15-50 equipped with precision control handwheel. In softwares (HySelect, HyTools) and balancing instrument (TA-SCOPE) the TA-BVS, DN 15-50, is named TA-BVS*.
Kv values for DN 65 and up remain the same.

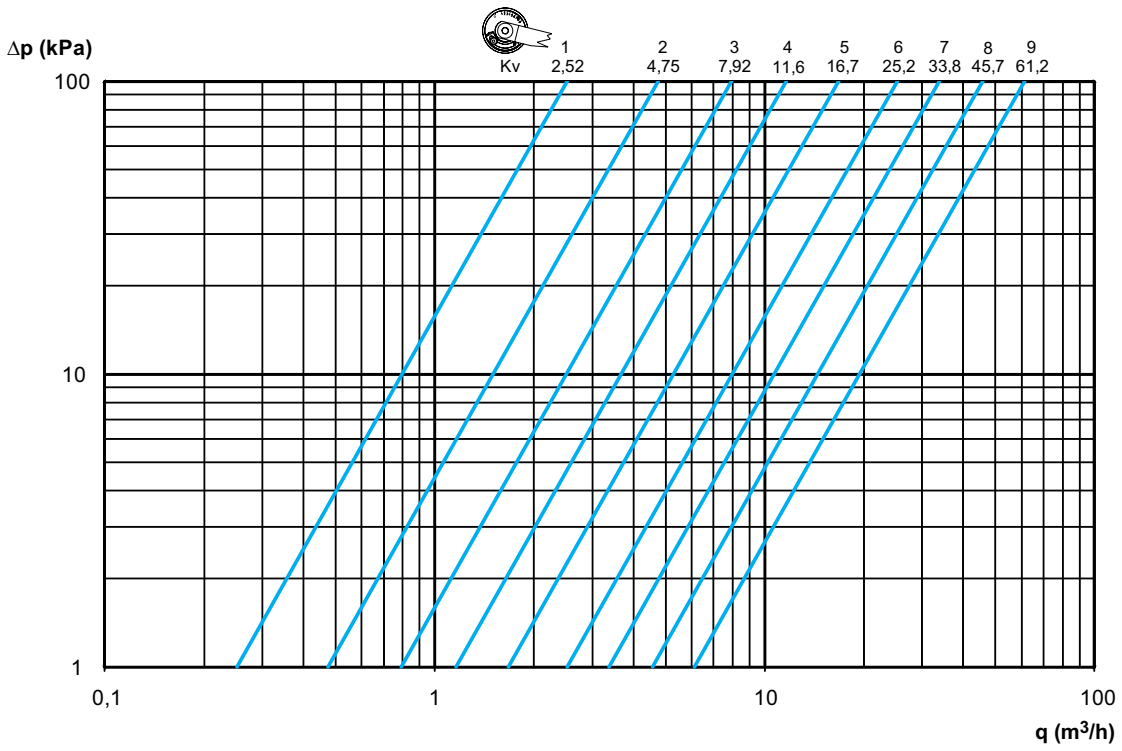
DN 65

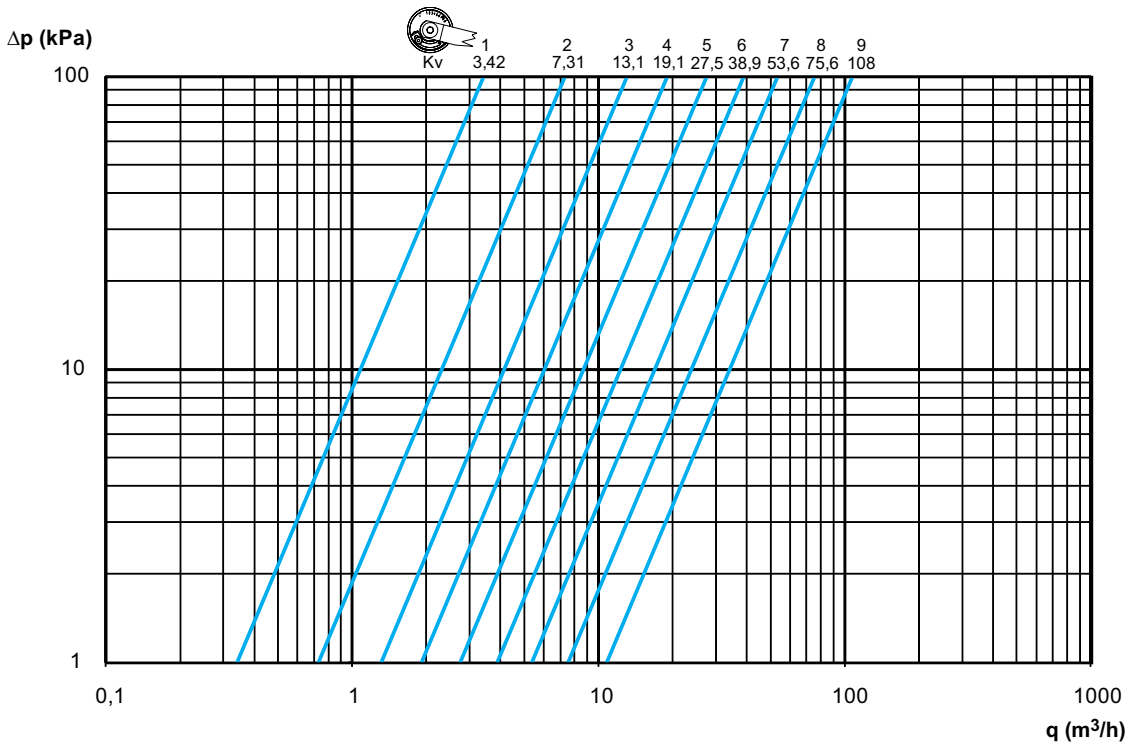

DN 80

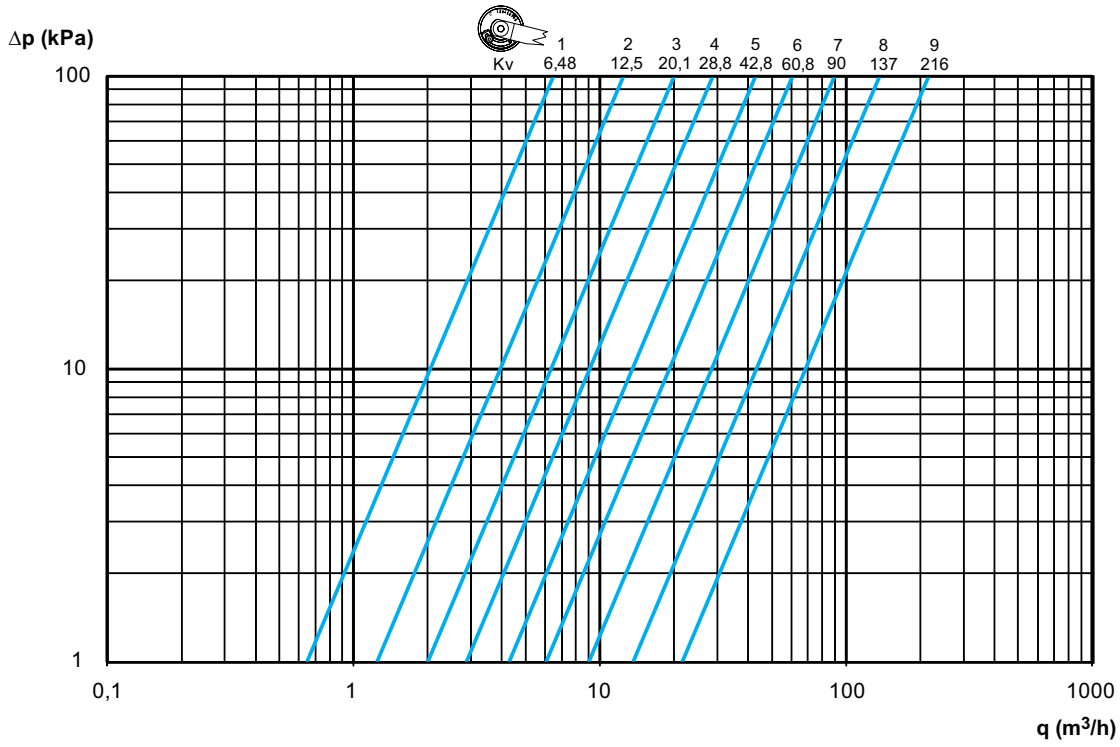
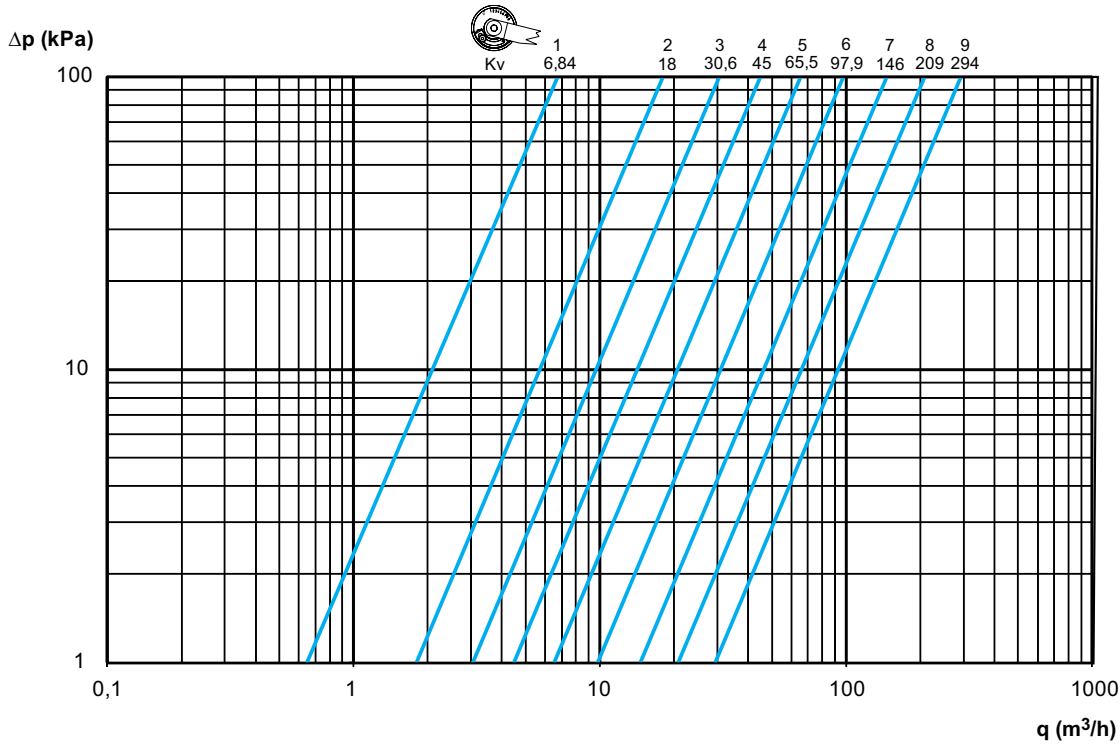

DN 100

DN 125

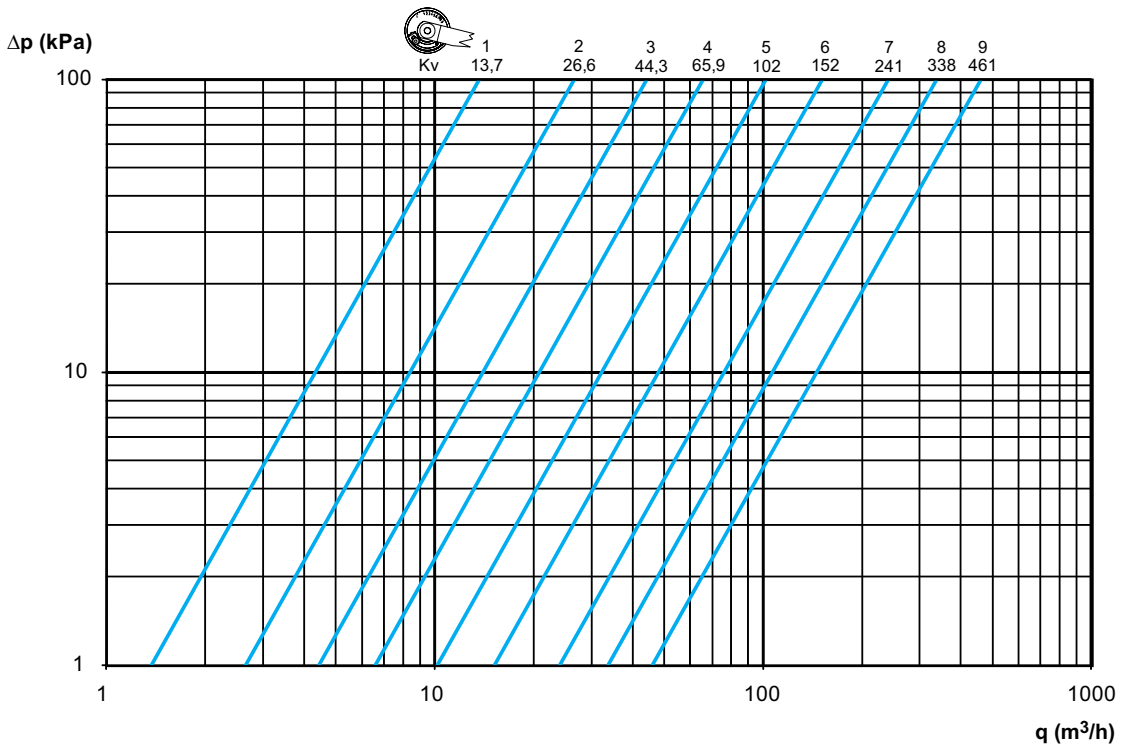
DN 150

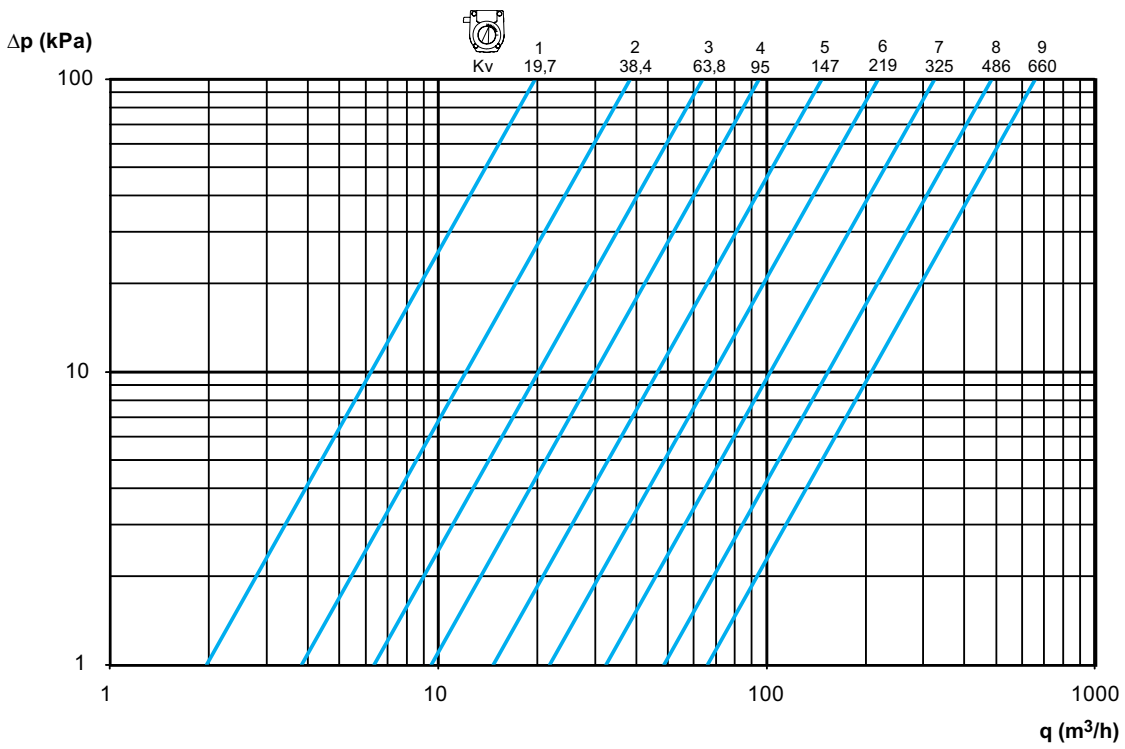

DN 200

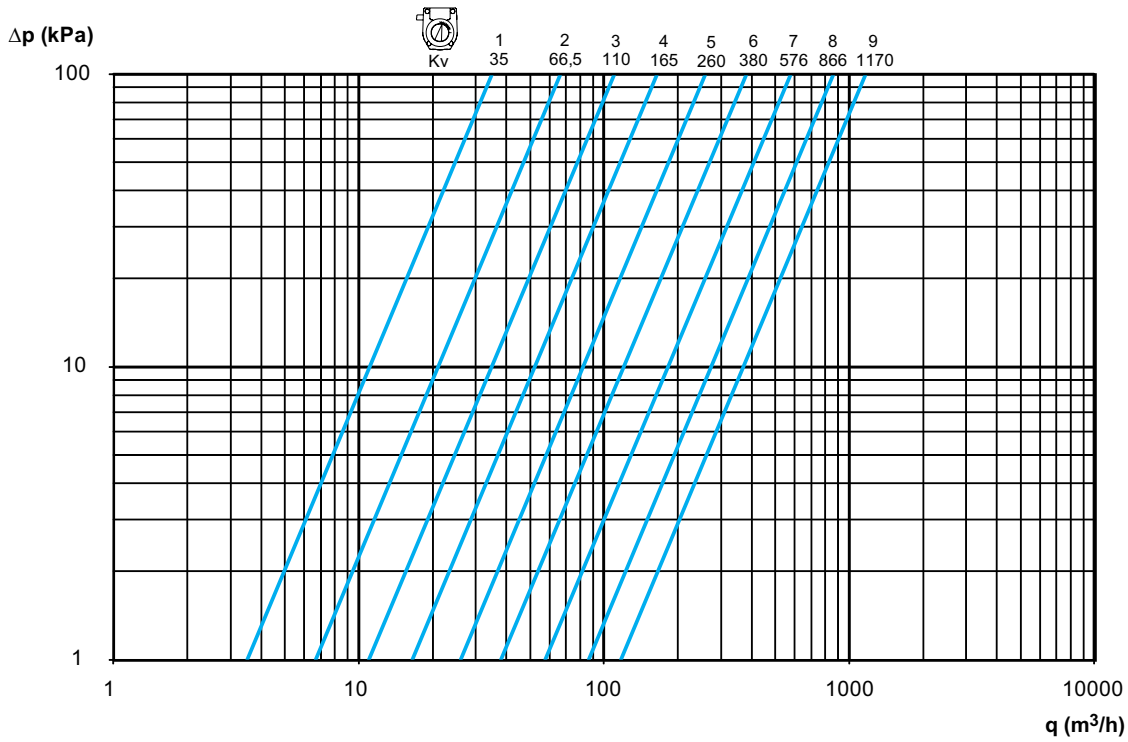
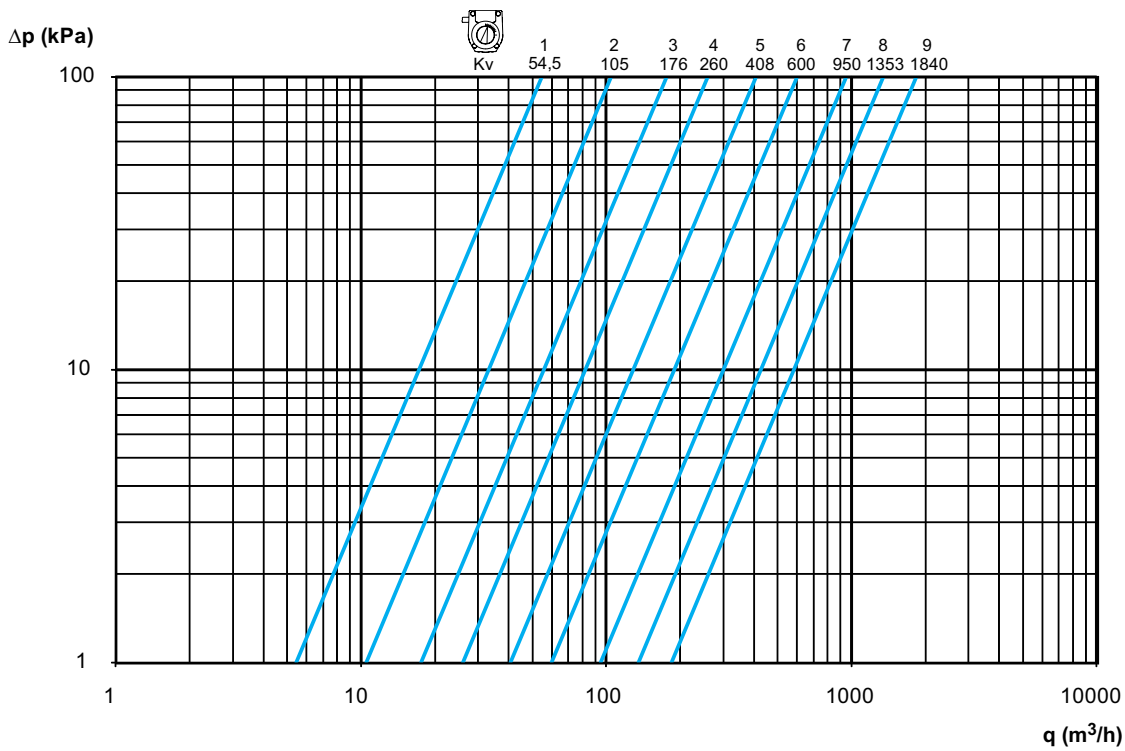

DN 250

DN 300

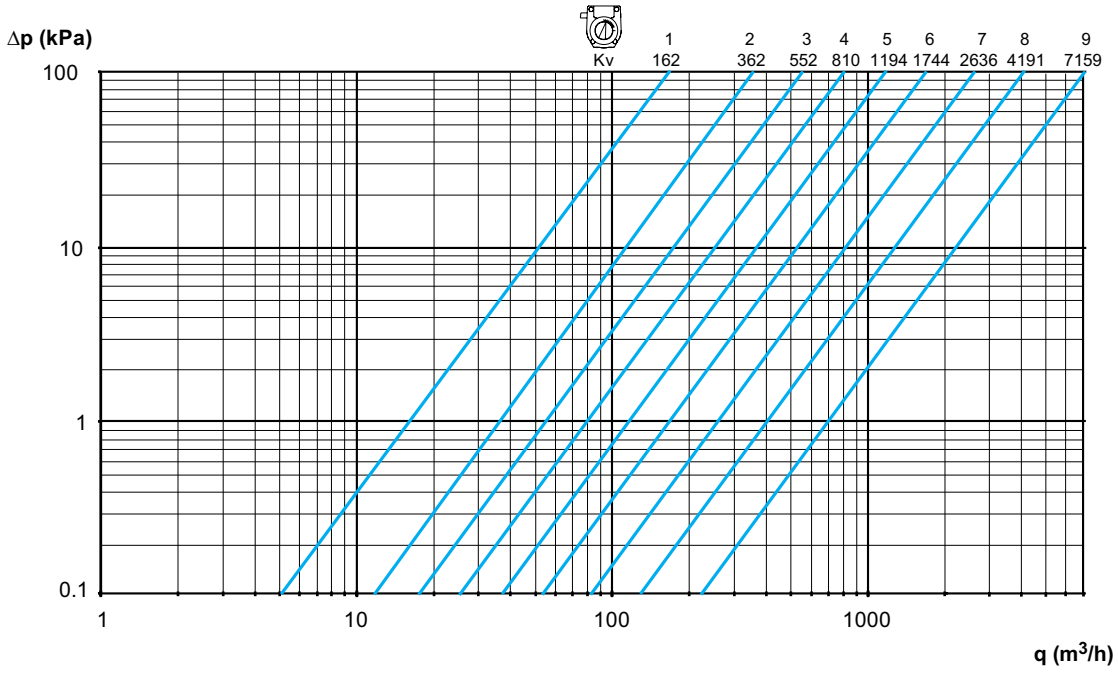
DN 400

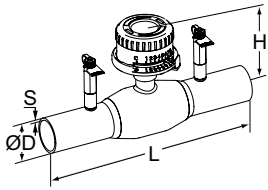

Articles



Welding ends – DN 15-50

Equipped with a precision control handwheel.
With measuring points.

PN 25

DN	ØD	L	H	S	Kvs	Kg	EAN	Article No
15	21,3	230	101	2,0	2,61	0,8	6415840116363	6-52 150-015
20	26,9	230	105	2,3	8,18	1,0	6415840116370	6-52 150-020
25	33,7	230	107	2,6	13,8	1,1	6415840116387	6-52 150-025
32	42,4	260	111	2,6	17,3	1,5	6415840116394	6-52 150-032
40	48,3	260	116	2,6	25,1	1,7	6415840116400	6-52 150-040
50	60,3	300	123	2,9	39,7	2,3	6415840116417	6-52 150-050

NOTE: New Kv values for valves DN 15-50 equipped with precision control handwheel. In softwares (HySelect, HyTools) and balancing instrument (TA-SCOPE) the TA-BVS, DN 15-50, is named TA-BVS*.

Kv values for DN 65 and up remain the same.

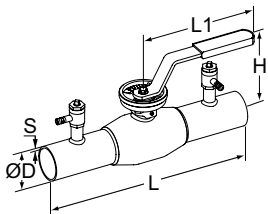

Welding ends – DN 65-150

Equipped with a removable handle.
With measuring points.

PN 25

DN	ØD	L	L1	H	S	Kvs	Kg	EAN	Article No
65	76,1	300	280	160	2,9	61,2	4,8	6415840183334	6-52 140-065
80	88,9	300	280	173	3,2	108	6,1	6415840183358	6-52 140-080
100	114,3	325	280	219	3,6	216	9,4	6415840183372	6-52 140-090
125	139,7	325	400	253	4,0	294	16	6415840183396	6-52 140-091
150	168,3	350	600	276	4,5	461	21	6415840183419	6-52 140-092

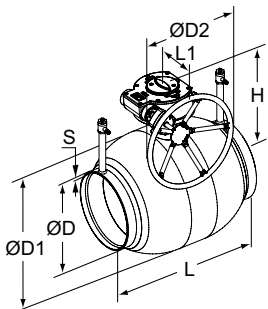

Welding ends – DN 200-300, 400

Equipped with manual gear.
DN 200-300 with measuring points. (DN 400 without measuring points)

PN 25

DN	ØD	ØD1	ØD2	L	L1	H	S	Kvs	Kg	EAN	Article No
200	219,1	273	250	400	268	293	4,5	660	45	6415840183433	6-52 140-093
250	273,0	356	300	530	301	345	5,0	1170	89	6415840183457	6-52 140-094
300	323,9	457	600	550	424	422	5,6	1840	140	6415840183471	6-52 140-095
400	406,1	610	500	762	440	573	7,0	7159	340	6415840116233	6-52 140-097

Kvs = m³/h at a pressure drop of 1 bar and fully open valve.

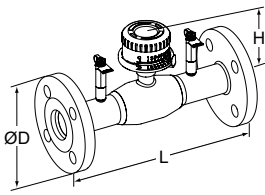
**Flanged – DN 15-50**

Equipped with a precision control handwheel.
With measuring points.

PN 25

DN	Number of bolt holes	ØD	L	H	Kvs	Kg	EAN	Article No
15	4x14	95	250	101	2,61	2,0	6415840426707	6-52 153-015
20	4x14	105	250	105	8,18	2,8	6415840426714	6-52 153-020
25	4x14	115	240	107	13,8	3,1	6415840426721	6-52 153-025
32	4x18	140	280	111	17,3	4,9	6415840426738	6-52 153-032
40	4x18	150	270	116	25,1	5,4	6415840426745	6-52 153-040
50	4x18	165	310	123	39,7	7,2	6415840426752	6-52 153-050

NOTE: New Kv values for valves DN 15-50 equipped with precision control handwheel. In softwares (HySelect, HyTools) and balancing instrument (TA-SCOPE) the TA-BVS, DN 15-50, is named TA-BVS*.

Kv values for DN 65 and up remain the same.

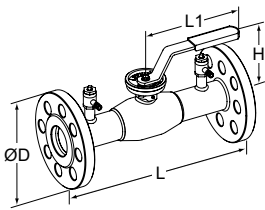
**Flanged – DN 65-150**

Equipped with a removable handle.
With measuring points.

PN 16

DN	Number of bolt holes	ØD	L	L1	H	Kvs	Kg	EAN	Article No
65	8x18	185	310	280	160	61,2	11	6415840183631	6-52 143-065
80	8x18	200	310	280	173	108	13	6415840183648	6-52 143-080
100	8x18	220	350	280	219	216	18	6415840183679	6-52 143-090
125	8x18	250	360	400	253	294	26	6415840183686	6-52 143-091
150	8x22	285	370	600	276	461	35	6415840183693	6-52 143-092

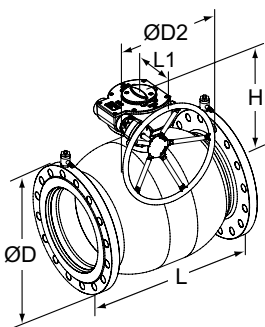
**Flanged – DN 200-300, 400**

Equipped with manual gear.

DN 200-300 with measuring points. (DN 400 without measuring points)

PN 16

DN	Number of bolt holes	ØD	ØD2	L	L1	H	Kvs	Kg	EAN	Article No
200	12x22	340	250	425	268	293	660	60	6415840183709	6-52 143-093
250	12x26	405	300	550	301	345	1170	114	6415840183716	6-52 143-094
300	12x26	460	600	580	424	422	1840	168	6415840183808	6-52 143-095
400	16x30	580	500	810	440	573	7159	382	6415840116486	6-52 143-097

Kvs = m³/h at a pressure drop of 1 bar and fully open valve.



The products, texts, photographs, graphics and diagrams in this document may be subject to alteration by IMI without prior notice or reasons being given. For the most up to date information about our products and specifications, please visit climatecontrol.imiplc.com.