

Climate
Control

IMI TA

TBV-CM



**Combined control & balancing valves for small
terminal units**

For modulating control

TBV-CM

Designed for use in terminal units in heating and cooling systems, the TBV-CM ensures accurate hydronic control and optimum throughput over a long lifetime. IMI's dezincification resistant alloy, AMETAL®, minimises the risk of leakage.

Key features

Presetting tool

For accurate and easy balancing.

Shut-off function

Ensures straightforward maintenance procedures.

Self-sealing measuring points

For quick and easy measurement.



Technical description

Application:

Heating and cooling systems.

Functions:

Control
Balancing
Pre-setting
Measuring
Shut-off (for isolation during system maintenance)

Dimensions:

DN 15-25

Pressure class:

PN 16

Temperature:

Max. working temperature: 120°C
Min. working temperature: -20°C

Lift:

4 mm

Leakage rate:

Tight sealing

Material:

Valve body: AMETAL®
Valve plug: PPS (polyphenylsulphide)
Seat seal: EPDM/Stainless steel (DN 15-20). EPDM/AMETAL® (DN 25).
Spindle seal: EPDM O-ring
Valve insert: AMETAL®, PPS (polyphenylsulphide)
Return spring: Stainless steel
Spindle: AMETAL®

AMETAL® is the dezincification resistant alloy of IMI.

Marking:

Body: TA, PN 16/150, DN, inch size and flow direction arrow.

Identification ring on measuring point:

White = Low flow (LF)

Black = Normal flow (NF)

Actuators:

See separate information on EMO TM.

Valve characteristics

TBV-CM LF, DN 15, Kvs 0,40

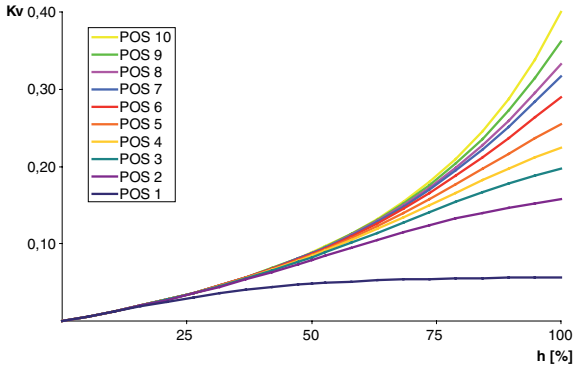

TBV-CM NF, DN 15, Kvs 1,0

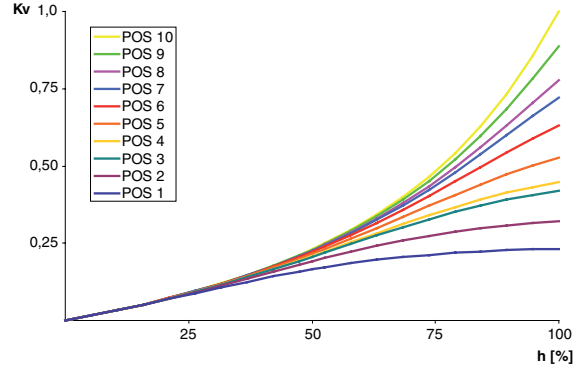

TBV-CM NF, DN 20, Kvs 2,0

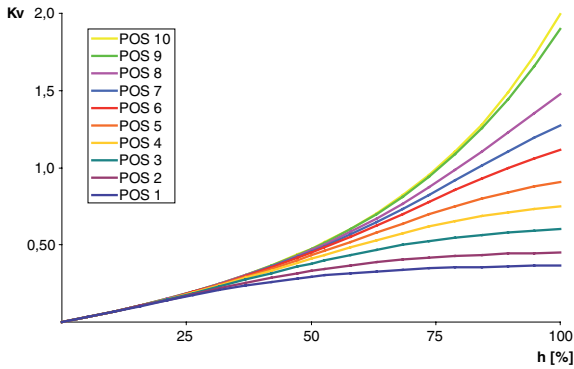

TBV-CM NF, DN 25, Kvs 4,0

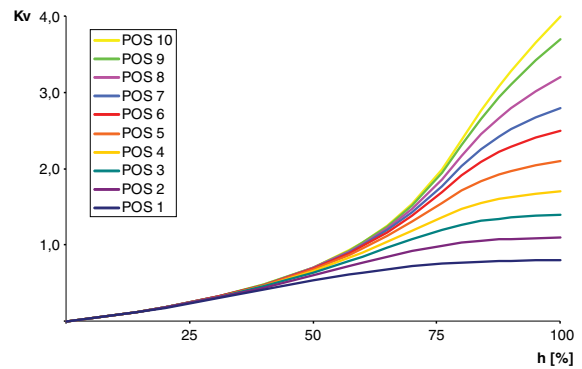

Standardised valve characteristic

TBV-CM LF, DN 15, Kvs 0,40

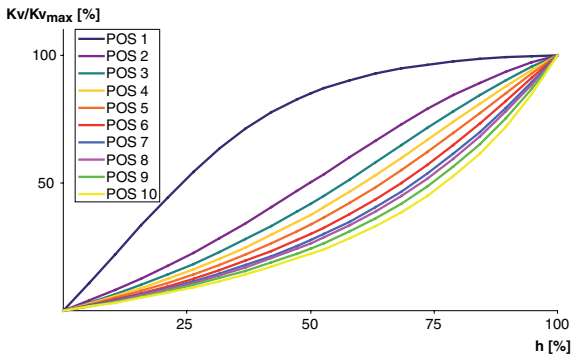

TBV-CM NF, DN 15, Kvs 1,0

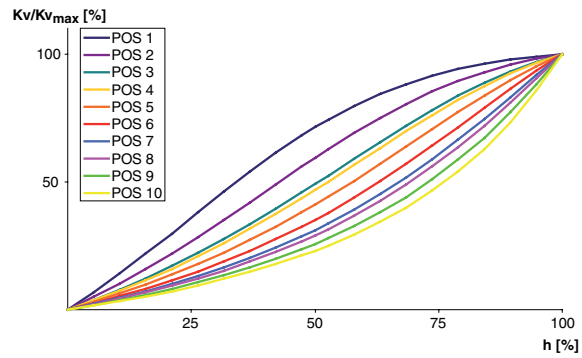

TBV-CM NF, DN 20, Kvs 2,0

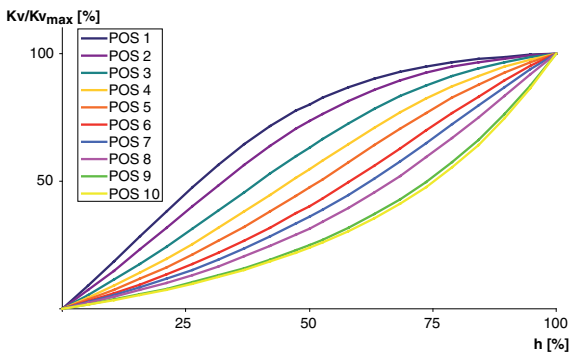

TBV-CM NF, DN 25, Kvs 4,0

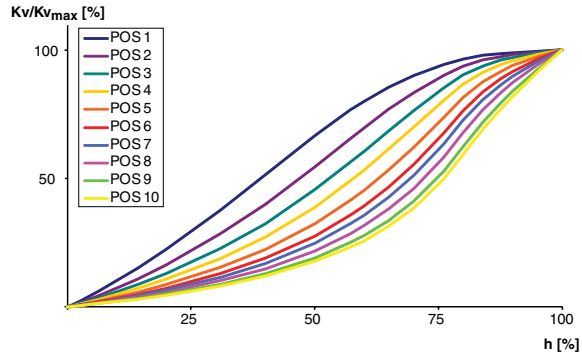

Kv_{max} = m³/h at a pressure drop of 1 bar at each pre-setting and fully open valve plug.
 Kvs = m³/h at a pressure drop of 1 bar and fully open valve.
 h = lift

Installation

Application example

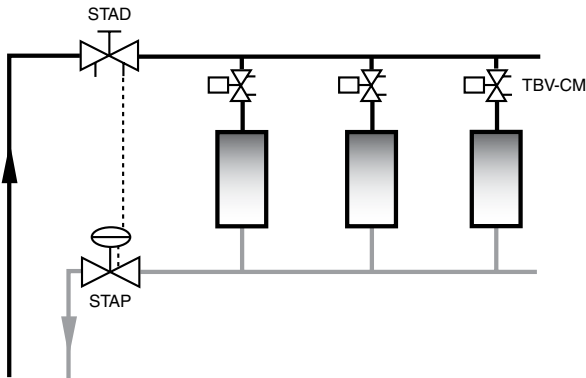

Flow direction

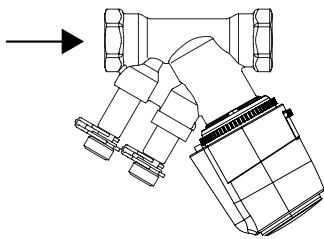

Installation of actuator EMO T

Approx. 15 mm of free space is required above the actuator.

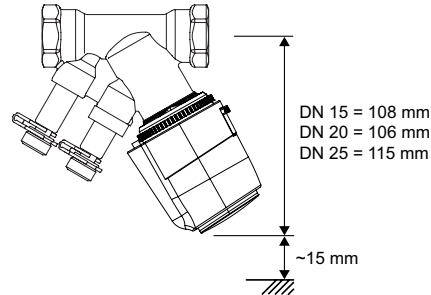

TBV-CM + EMO TM

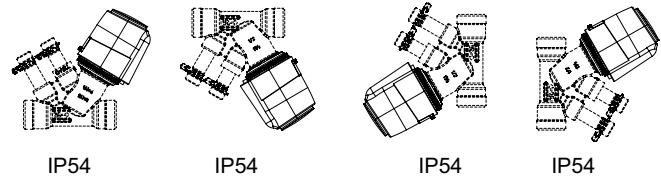

Sizing

When Δp and the design flow are known, use the formula to calculate the Kv-value.

$$Kv = 0,01 \frac{q}{\sqrt{\Delta p}} \quad q \text{ l/h, } \Delta p \text{ kPa}$$

$$Kv = 36 \frac{q}{\sqrt{\Delta p}} \quad q \text{ l/s, } \Delta p \text{ kPa}$$

Setting

TBV-CM is delivered with a red protective cap, Article No 52 143-100, which must be used when isolating the valve.

TBV-CM is delivered with the pre-setting fully open. Pre-setting of a valve for a given Kv_{max} value, e.g. corresponding to position 5, is done as follows:

1. Place the presetting tool, Article No 52 133-100, at the valve.
2. Turn the presetting tool so that position 5 is pointing at the index* of the valve body.
3. Remove the adjustment tool. The valve is now pre-set.

There is a diagram for every valve size that shows the flow for different pressure drops and settings.

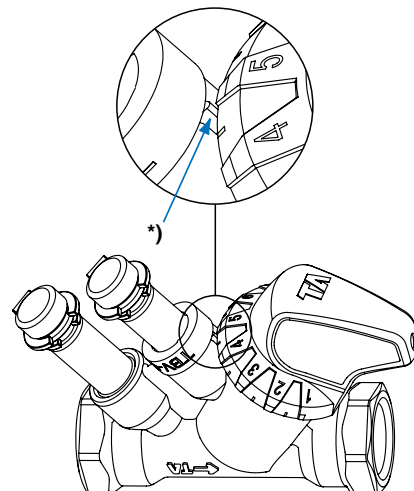

Noise

In order to avoid noise in the installation the flows must be correctly balanced and the water de-aerated. Excessive differential pressures can cause noise in the installations, and in that case, differential pressure controllers should be used.

The maximum recommended pressure drop in order to avoid noise is 30 kPa = 0,3 bar.

Measuring accuracy

Maximum flow deviation at different settings

TBV-CM LF

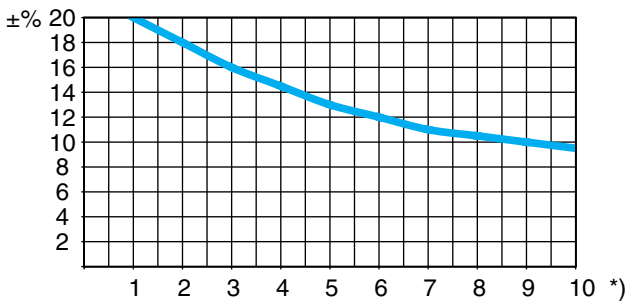

TBV-CM NF

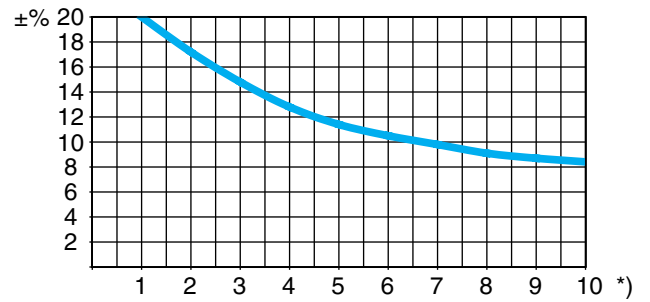

*) Position

Try to avoid mounting taps and pumps, immediately before the valve.

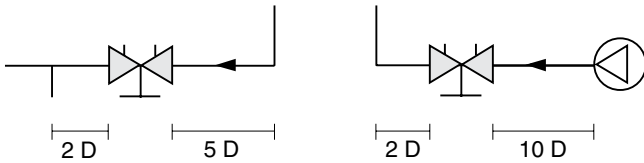

Closing force

Necessary force (F) to close the valve versus the differential pressure (Δp V).

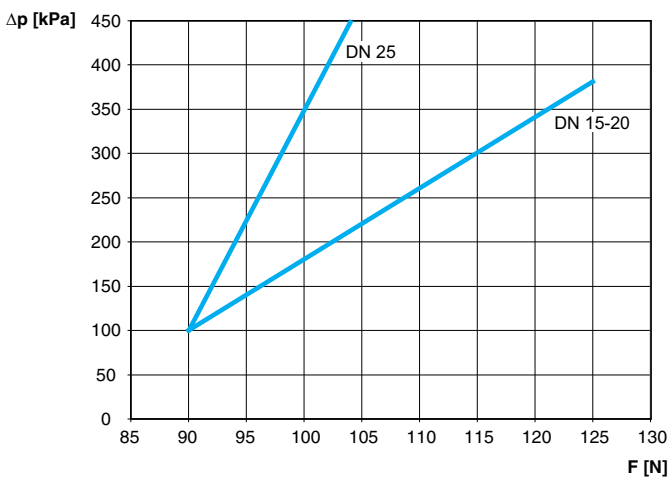
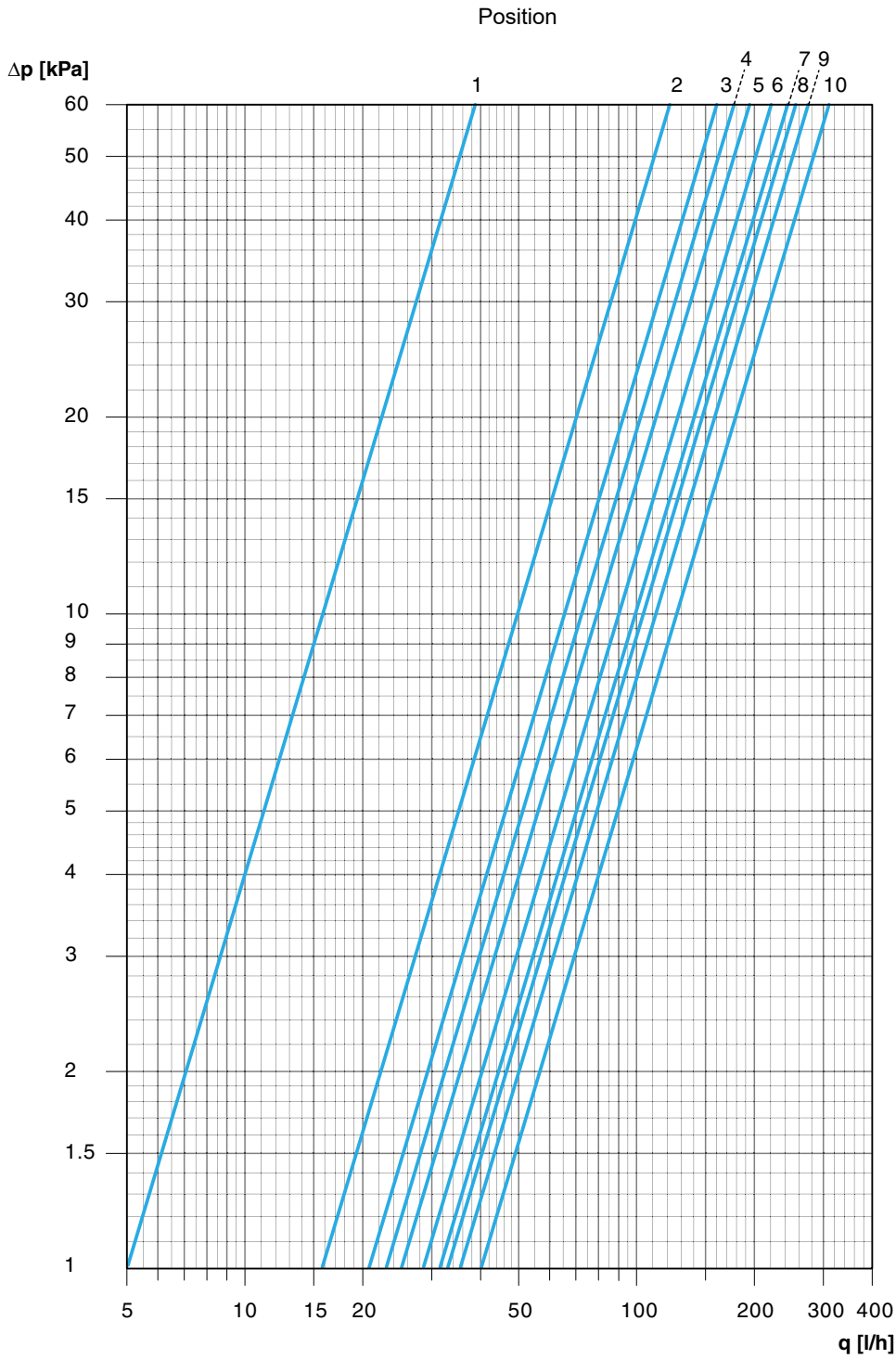

Diagram TBV-CM LF, DN 15



Position	1	2	3	4	5	6	7	8	9	10
Kv_{max}	0,05	0,16	0,21	0,23	0,25	0,29	0,31	0,33	0,35	0,40

Kv_{max} = m³/h at a pressure drop of 1 bar at each pre-setting and fully open valve plug.

Diagram TBV-CM NF, DN 15

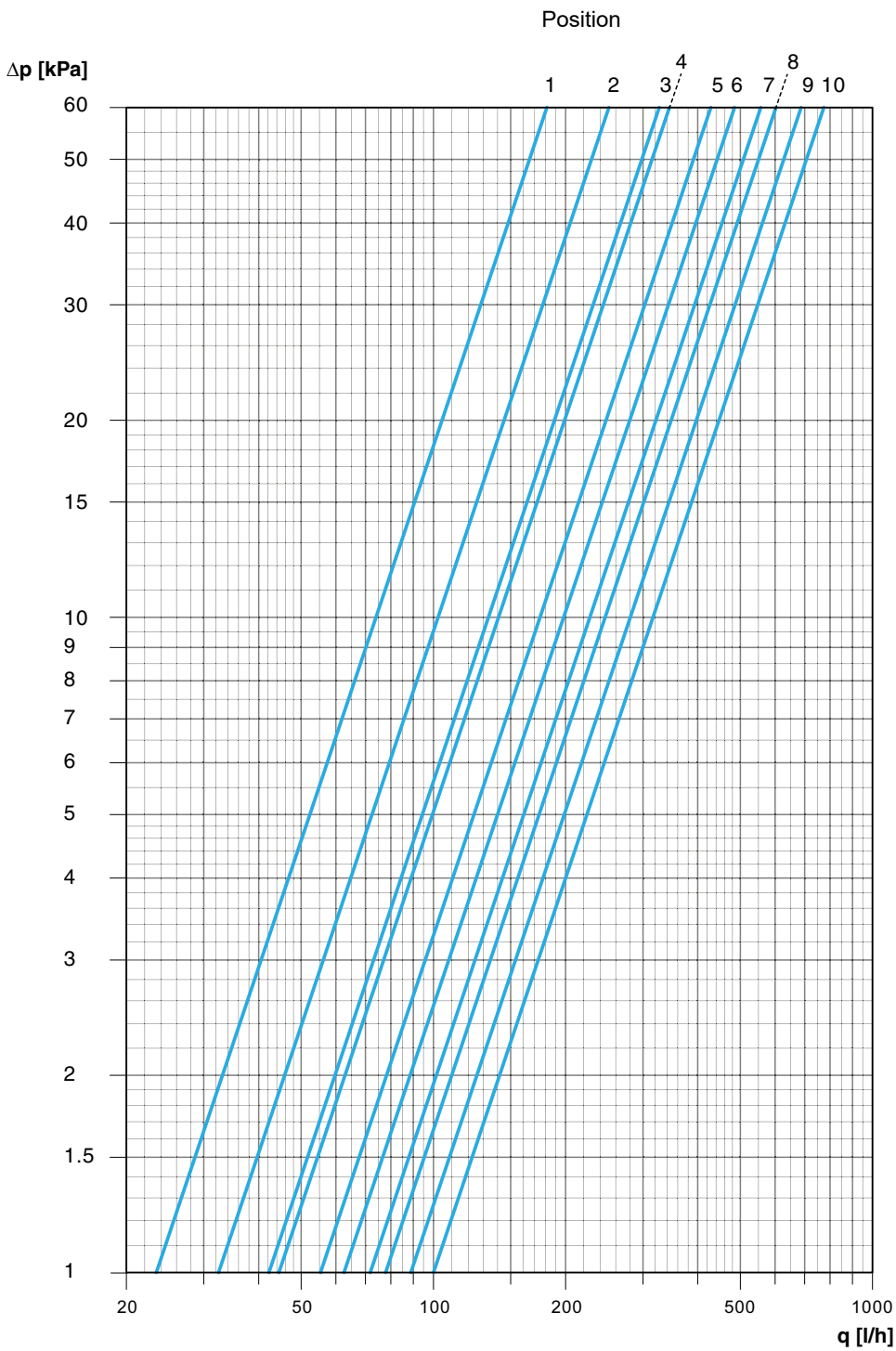

Position	1	2	3	4	5	6	7	8	9	10
Kv_{max}	0,23	0,32	0,42	0,45	0,55	0,63	0,72	0,78	0,89	1,0

Kv_{max} = m³/h at a pressure drop of 1 bar at each pre-setting and fully open valve plug.

Diagram TBV-CM NF, DN 20

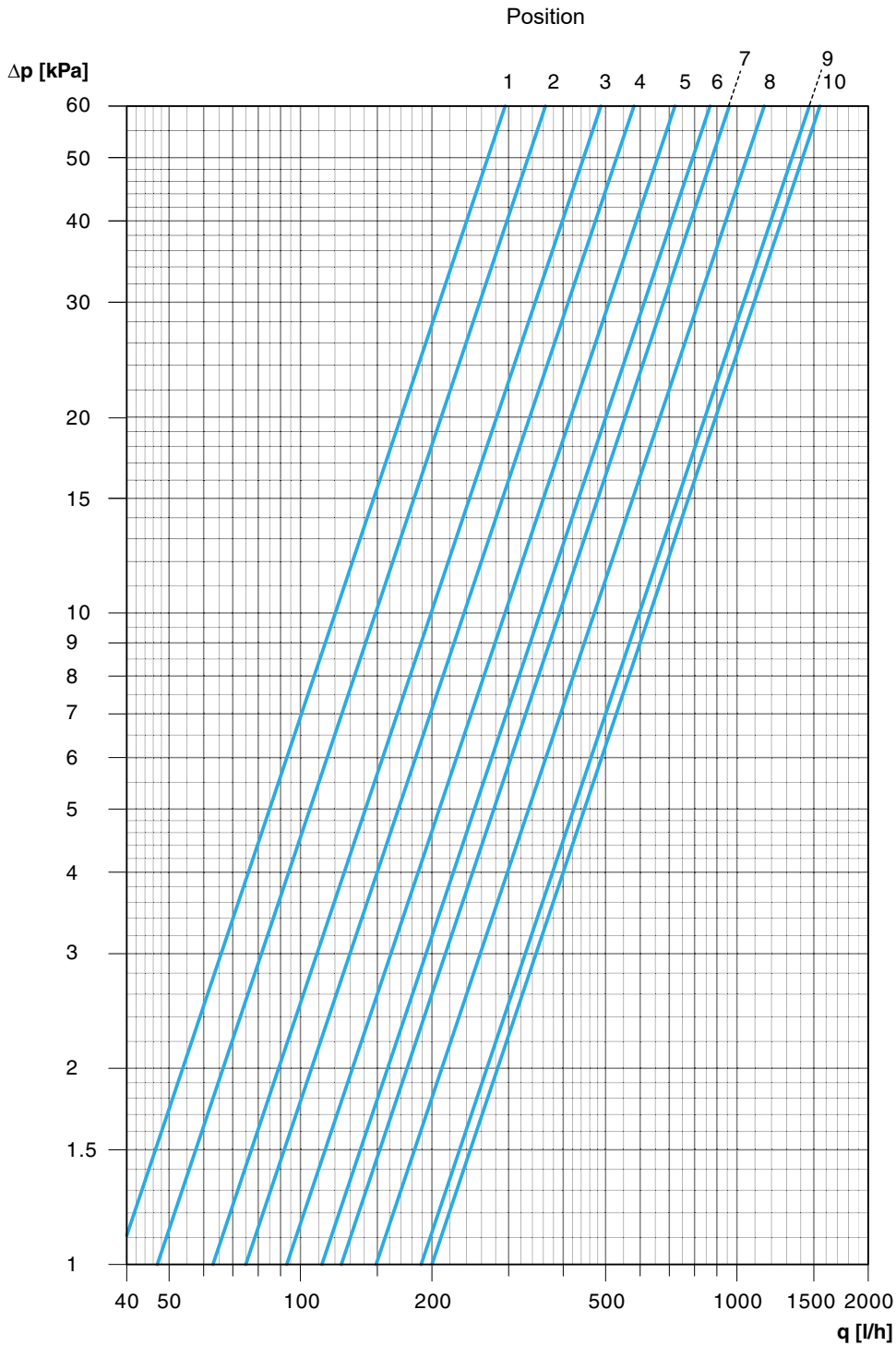

Position	1	2	3	4	5	6	7	8	9	10
Kv_{max}	0,38	0,47	0,63	0,75	0,93	1,1	1,2	1,5	1,9	2,0

Kv_{max} = m³/h at a pressure drop of 1 bar at each pre-setting and fully open valve plug.

Diagram TBV-CM NF, DN 25

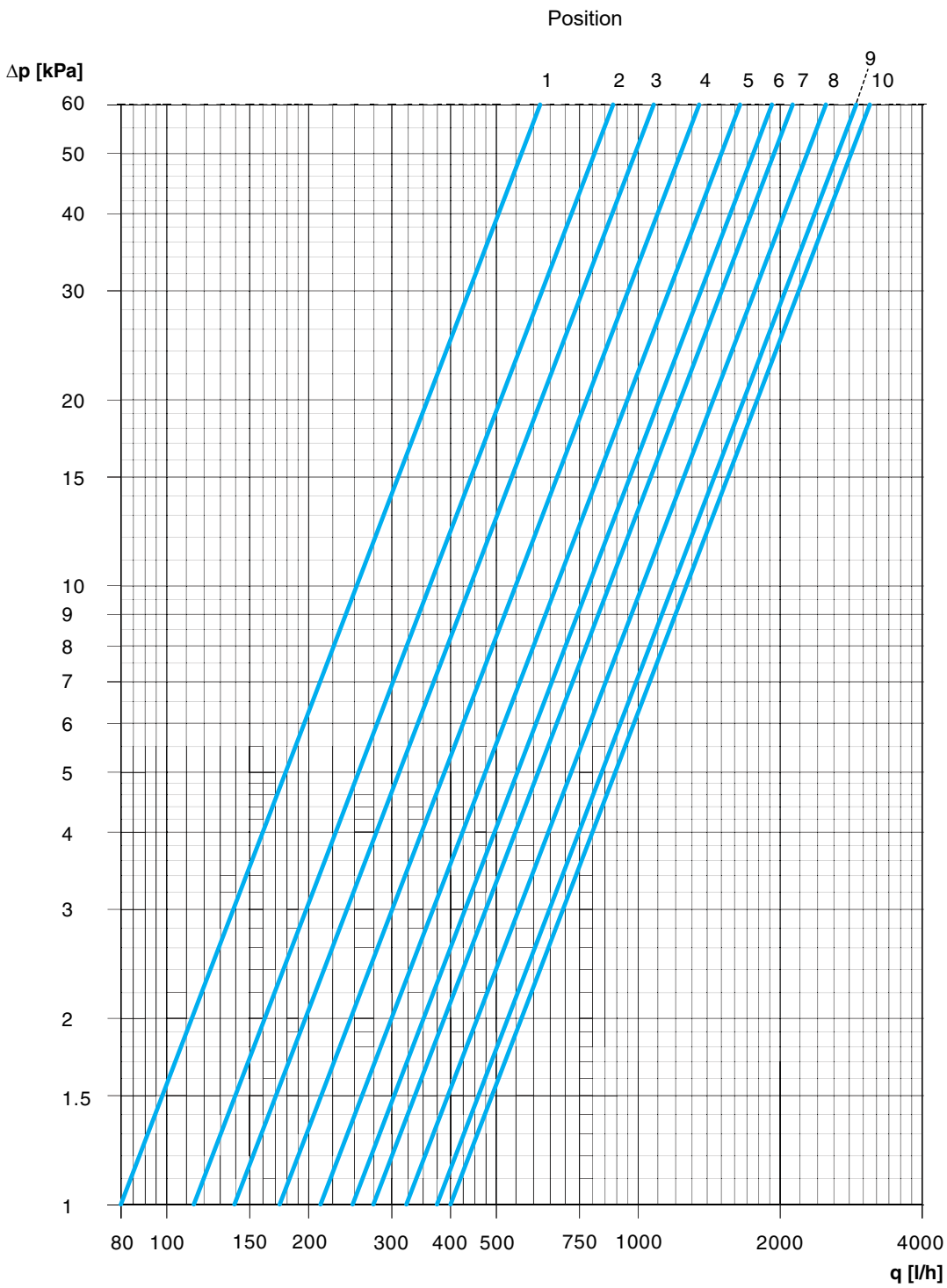

Position	1	2	3	4	5	6	7	8	9	10
Kv_{max}	0,80	1,1	1,4	1,7	2,1	2,5	2,8	3,2	3,7	4,0

Kv_{max} = m³/h at a pressure drop of 1 bar at each pre-setting and fully open valve plug.

Articles

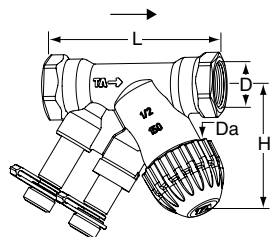

Internal thread

DN	D	Da*	L	H	Kvs	Kg	EAN	Article No
TBV-CM LF, low flow								
15	G1/2	M30x1,5	81	58	0,40	0,34	7318793950703	52 143-115
TBV-CM NF, normal flow								
15	G1/2	M30x1,5	81	58	1,0	0,34	7318793950505	52 144-115
20	G3/4	M30x1,5	91	57	2,0	0,40	7318793951403	52 144-120
25	G1	M30x1,5	111	64	4,0	0,73	7318793977502	52 144-125

*) Connection to actuator.

Kvs = m³/h at a pressure drop of 1 bar and fully open valve.

G = Thread according to ISO 228. Thread length according to ISO 7/1.

→ = Flow direction

TBV-CM (DN 15-20) can be connected to smooth pipes by KOMBI compression coupling.
(See catalogue leaflet KOMBI)

Accessories



Presetting tool

For TBV-C, TBV-CM

EAN

Article No

7318793886002

52 133-100

Actuator EMO TM

For more details of EMO TM, see separate catalogue leaflet.

TBV-CM is developed to work together with the EMO TM actuator. Actuators of other brands require a working range of:

X = 11,50 - 15,80 (closed - fully open)

IMI will not be held responsible for the control function if other brands of actuator are used.

