

Climate
Control

IMI TA

TA-Slider 160 KNX



Actuators

Digitally configurable proportional push actuator for
Bus communication with KNX – 160/200 N

TA-Slider 160 KNX

Digitally configurable actuators for Bus communication with KNX. A wide range of setup options provide extensive flexibility for on-site parameter adaptation. Fully programmable binary input, relay and adjustable max. stroke of the valve bring new opportunities for advanced hydronic control and balancing.

Key features

Fully configurable

More than 100 setup options allow input and output signals, binary input, relay, characteristics and many other parameters to be configured.

Easy diagnostics

Reports five different types of errors to allow system faults to be found quickly.

Perfection in connectivity

Dedicated versions allow configuring, controlling and communicating via KNX Bus.



Technical description

Functions:

Proportional control
Stroke detection
Self-adjusting force
Mode, status and position indication
Stroke limitation setting
Minimum stroke setting
Valve blockage protection
Valve clogging detection
Error safe position
Diagnostic/Logging

KNX version:

+ 1 binary input, max. 100 Ω, cable max. 10 m or shielded.

KNX R24 version:

+ 1 binary input, max. 100 Ω, cable max. 10 m or shielded.
+ 1 relay, max. 2A, 30 VAC/VDC on resistive load

Supply voltage:

Powered by KNX Bus.

Power consumption:

Typical 216 mW; Maximum 600 mW.

Input signal:

By KNX Bus.

Output signal:

By KNX Bus.

Characteristics:

Linear, EQM 0.25 and inverted EQM 0.25.
Default setting: Linear.

Control speed:

10 s/mm

Adjusting force:

160/200 N
Self-adjusting for IMI TA/IMI Heimeier valves.

Temperature:

Media temperature: max. 120°C
Operating environment: 0°C – +50°C (5-95%RH, non-condensing)
Storage environment: -20°C – +70°C (5-95%RH, non-condensing)

Ingress protection:

IP54 (all directions)
(according to EN 60529)

Protection class:

(according to EN 61140)
III (SELV)

Cable:

1, 2 or 5 m.
Halogen free as option, fire class B2_{ca} – s1a, d1, a1 according to EN 50575.
KNX: type J-YY, 2x2x0.6 mm².
KNX R24: type J-YY, 2x2x0.6 mm² and relay cable type LiYY, 3x0.34 mm², with wire end sleeves.

Stroke:

6.9 mm
Automatic detection of the valve lift (stroke detection).

Noise level:

Max. 30 dBA

Weight:

0.20 kg

Connection to valve:

Swivelling nut M30x1,5.

Material:

Cover: PC/ABS GF8
Housing: PA GF40.
Swivelling nut: Nickel-plated brass.

Colour:

White RAL 9016, grey RAL 7047.

Marking:

Label: IMI TA, CE, product name, article No. and technical specification.

Certification CE:

LV-D. 2014/35/EU: EN 60730-1, -2-14.
EMC-D. 2014/30/EU: EN 60730-1, -2-14.
RoHS-D. 2011/65/EU: EN 50581.

Product standard:

EN 60730.

Function

Setting

The actuator can be set through the KNX ETS software (minimum required ETS version is ETS5.0). The programming of the physical address can be carried out without contact by placing a magnet as shown below.

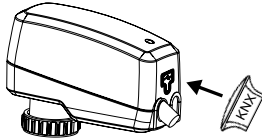

Calibration/Stroke detection

According to selected settings in the table.

Type of calibration	At power on	After manual override
Both end positions (full)	√ *	√
Fully extended position (fast)	√	√ *
None	√	

*) Default

Note: A calibration refresh can be automatically repeated monthly or weekly.
Default setting: Off.

Self-adjusting force

Automatic valve type detection, the force is set to 160 or 200 N for IMI TA/IMI Heimeier valves.
Default setting: On.

Stroke limitation setting

A maximum stroke smaller than or equal to the detected valve lift can be set to the actuator.
Default setting: No stroke limitation (100%).

Minimum stroke setting

The actuator can be set with a minimum stroke below which it will not go (except for calibration).
For some IMI TA/IMI Heimeier valves, it can also be set to a qmin.
Default setting: No minimum stroke (0%).

Valve blockage protection

The actuator will perform a quarter of a full stroke and then back to desired value if no actuation takes place for one week or one month.
Default setting: Off.

Valve clogging detection

If actuation stops before the desired value is reached, the actuator moves back ready to make a new attempt. The actuator will move to the configured error safe position after three attempts.
Default setting: On.

Error safe position

Fully extended or retracted position when following errors occur; low power, line break, valve clogging or stroke detection failure.
Default setting: Fully extended position.

Diagnostics/logging

Five different errors (low power, signal out of range, valve clogging, stroke detection failure, cyclic timeout) can be reported on KNX Bus. Logged errors will be cleared if the power is disconnected.

Binary input

If the binary input circuit is open, the actuator will go to a set stroke, switch to a second stroke limitation setting or drive to its full stroke regardless of any limitations for flushing purpose. See also Change-over system detection.
Default setting: Off

Change-over system detection

Switching between two different stroke limitation settings by toggling the binary input or via KNX.

Connection interfaces for KNX Bus communication

Twisted pair; KNX/TP
More detailed information, please see TA-Slider 160 KNX and KNX R24 protocol implementation documents.

LED indication

		Status	Red (heating) / Blue (cooling)
		Fully retracted (actuator stem)	Long pulse - Short pulse
		Fully extended (actuator stem)	Short pulse - Long pulse
		Intermediate position	Long pulses
		Moving	Short pulses
		Calibrating	2 short pulses
		Manual mode or no power supply	Off

		Error code	Violet
		Power supply too low	1 pulse
		Cyclic control time-out	2 pulses
		Valve clogging or foreign object	3 pulses
		Stroke detection failure	4 pulses

If an error is detected, violet pulses are displayed as the red or blue status lights flash alternately. More detailed information, please see the HyTune app + TA-Dongle.

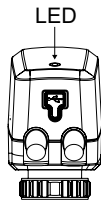

Installation

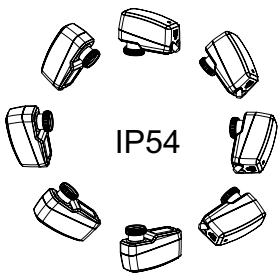

Note!

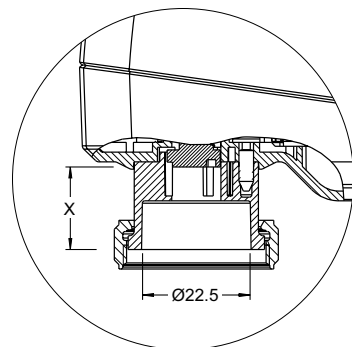
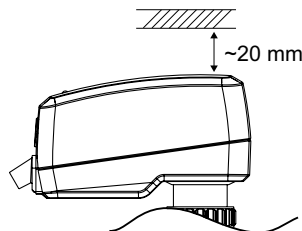

$$X = 10.0 - 16.9$$

Connection diagrams

TA-Slider 160 KNX

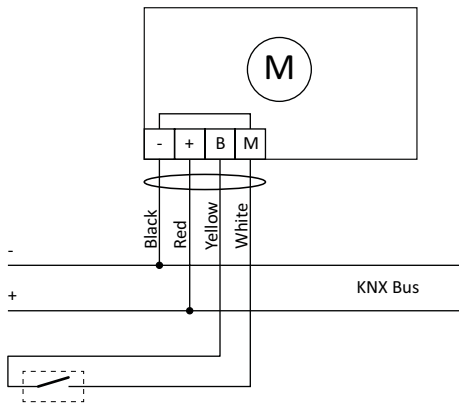

TA-Slider 160 KNX R24

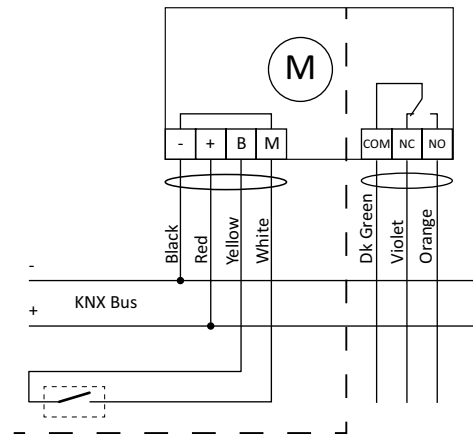

Note: M terminal is internally connected to KNX “-” Bus wire.

Terminal	Description
M	Neutral for potential free contact
B	Connection for potential free contact (e.g. open window detection), max. 100 Ω, max. 10 m cable or shielded
COM	KNX R24 version: Common relay contact, max. 30 VAC/DC, max. 2A on resistive load.
NC	Normally closed contact for relay
NO	Normally open contact for relay

Articles - TA-Slider 160 KNX

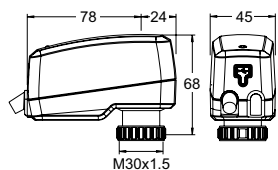

TA-Slider 160 KNX
Twisted pair; KNX/TP

With binary input

Cable length [m]	Bus	EAN	Article No
1	KNX	5902276883392	322224-01001
2	KNX	5902276883408	322224-01002
5	KNX	5902276883415	322224-01003
With halogen free cable			
1	KNX	5902276883422	322224-01004
2	KNX	5902276883439	322224-01005
5	KNX	5902276883446	322224-01006

Articles - TA-Slider 160 KNX R24

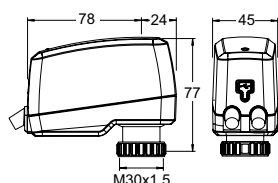

TA-Slider 160 KNX R24
Twisted pair; KNX/TP

With binary input and relay 24V

Cable length [m]	Bus	EAN	Article No
1	KNX	5902276896019	322224-01301
2	KNX	5902276896026	322224-01302
5	KNX	5902276896033	322224-01303
With halogen free cable			
1	KNX	5902276896040	322224-01304
2	KNX	5902276896057	322224-01305
5	KNX	5902276896064	322224-01306

Additional equipment



Programming magnet

For programming the physical addresses without contact.

EAN	Article No
4024052149919	1865-01.433