

Climate
Control

IMI TA

TA-COMPACT-DP



Combined Δp controller, balancing and control valves

For small pressure independent circuits

TA-COMPACT-DP

The TA-COMPACT-DP is the ideal solution for zone control of small circuits, enables setting of max. flow and prevent control valves from too high differential pressure. TA-COMPACT-DP combines 5 functions: differential pressure control, balancing, control, diagnostics and shut-off.

Key features

5 in 1 concept reduces costs

Installing one valve with 5 functions reduces investment costs and installation time.

Saves energy and money

Balanced and pressure independent circuits protects systems against over flows and too high energy consumption.

Zone control

Time controlled circuits can save up to 20% energy.

Noise protection

Differential pressure control protects control valves from too high differential pressure.



Technical description

Application:

Heating and cooling systems.

Functions:

Pre-setting (max. flow)
Differential pressure control
Control
Measuring (ΔH , T, q)
Isolation (for use during system maintenance – see “Leakage rate”)

Dimensions:

DN 10-25

Pressure class:

PN 16

Differential pressure (ΔH):

Max. differential pressure (ΔH_{\max}):
400 kPa = 4 bar

Min. differential pressure (ΔH_{\min}):

DN 10: 20 kPa = 0,20 bar

DN 15: 18 kPa = 0,18 bar

DN 20: 21 kPa = 0,21 bar

DN 25: 25 kPa = 0,25 bar

(Valid for the most demanding settings.

Other settings will require a lower ΔH .

Check with graphs under “Sizing” or software HySelect.)

ΔH_{\max} = The maximum allowed pressure drop over the circuit, to fulfill all stated performances.

ΔH_{\min} = The minimum needed pressure drop over the circuit, for proper differential pressure control.

Setting range:

Indication of recommended setting range. For more detailed information see “Sizing”.

(Δp_L 10 kPa)

DN 10: 16-71 l/h

DN 15: 60-300 l/h

DN 20: 160-840 l/h

DN 25: 280-1500 l/h

Temperature:

Max. working temperature: 120°C

Min. working temperature: -20°C

Media:

Water or neutral fluids, water-glycol mixtures (0-57%).

Lift:

4 mm

Leakage rate:

Leakage flow $\leq 0,01\%$ of max. recommended flow (setting 10) in correct flow direction.
(Class IV according to EN 60534-4).

Characteristics:

Linear, best suited for on/off control.

Material:

Valve body: AMETAL®

Valve insert: AMETAL®

Valve plug: Brass CW724R (CuZn21Si3P)

Spindle: Stainless steel

Spindle seal: EPDM O-ring

Δp insert: AMETAL®, PPS

(polyphenylsulphide)

Membrane: EPDM and HNBR

Springs: Stainless steel

O-rings: EPDM

AMETAL® is the dezincification resistant alloy of IMI.

Marking:

TA, IMI, PN 16, DN and flow direction arrow.

Grey handwheel: TA-COMPACT-DP and DN.

Connection:

External thread according to ISO 228.

Connection to actuator:

M30x1.5

Actuators:

See separate technical documentation on EMO T.

Measuring accuracy

Maximum flow deviation at different settings

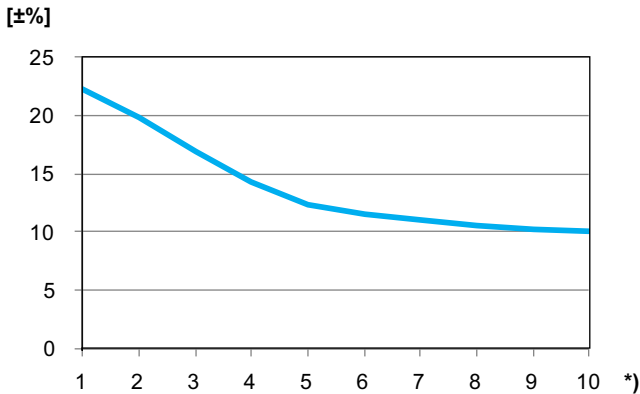

*) Setting

Correction factors

The flow calculations are valid for water (+20°C). For other liquids with approximately the same viscosity as water ($\leq 20 \text{ cSt} = 3^\circ \text{E} = 100 \text{ S.U.}$), it is only necessary to compensate for the specific density. However, at low temperatures, the viscosity increases and laminar flow may occur in the valves.

This causes a flow deviation that increases with small valves, low settings and low differential pressures. Correction for this deviation can be made with the software HySelect or directly in our balancing instruments.

Noise

In order to avoid noise in the installation, the valve must be correctly installed and the water de-aerated.

Actuators

TA-COMPACT-DP is developed to work together with recommended actuators according to table. Care should be taken by the user to ensure that actuators not manufactured by IMI are fully compatible to provide optimal control from the valve. Failure to do so may provide unsatisfactory results. See separate catalogue leaflets for more details about the actuators.

Actuators of other brands require;
 Working range: X (closed - fully open) = 11,6 - 15,8
 Closing force: Min. 125 N (max. 500 N)

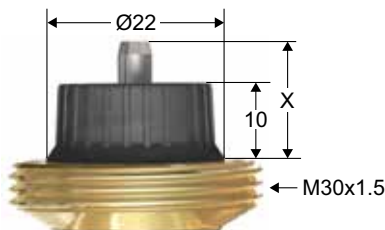

If TA-COMPACT-DP is used with EMO TM the setting of the valve must be setting 3 or higher in order to achieve the minimum stroke of 1 mm.

Maximum recommended pressure drop (ΔpV) for valve and actuator combination

The maximum recommended pressure drop over a valve and actuator combination for close off (ΔpV_{close}) and to fulfill all stated performances (ΔpV_{max}).

DN	EMO T/EMO TM * [kPa]
10	400
15	
20	
25	

*) Closing force 125 N.

ΔpV_{close} = The maximum pressure drop that the valve can close against from an opened position, with a specified force (actuator) without exceeding stated leakage rate.

ΔpV_{max} = The maximum allowed pressure drop over the valve to fulfill all stated performances.

Sizing

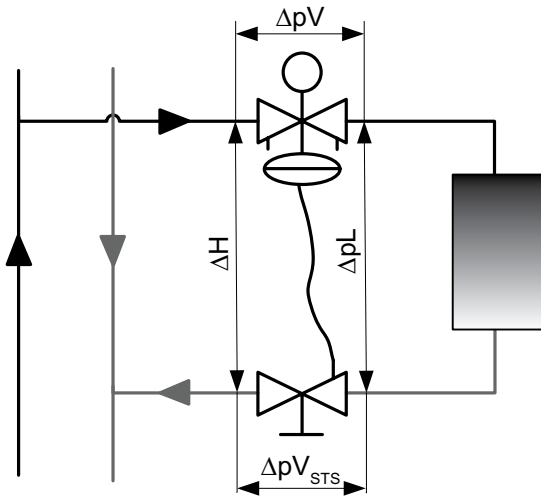

ΔpL = The differential pressure over the load.
 ΔH = Available differential pressure.
 ΔH_{\min} = The minimum needed pressure drop over the circuit, for proper differential pressure control.

$$\Delta H = \Delta pV + \Delta pL + \Delta pV_{STs}$$

*

Diagrams

The colored curves (1-10) are the nominal ΔpL for different settings (1-10) of TA-COMPACT-DP as a function of flow (q). The black curve is ΔH_{\min} as a function of flow (q). The green area is the recommended area of sizing.

DN 10

ΔpL (ΔH_{\min})
[kPa]

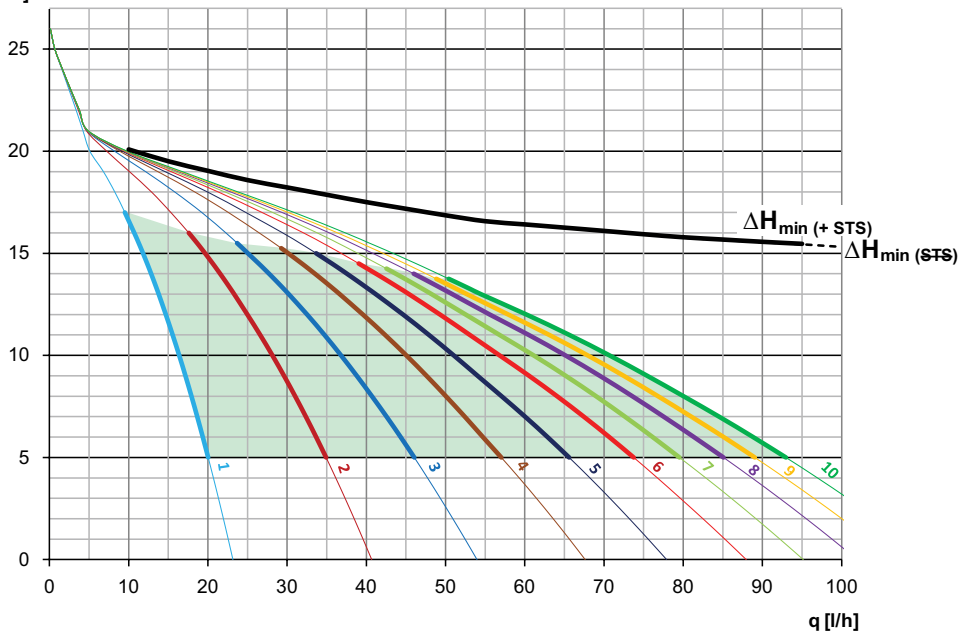

DN 15

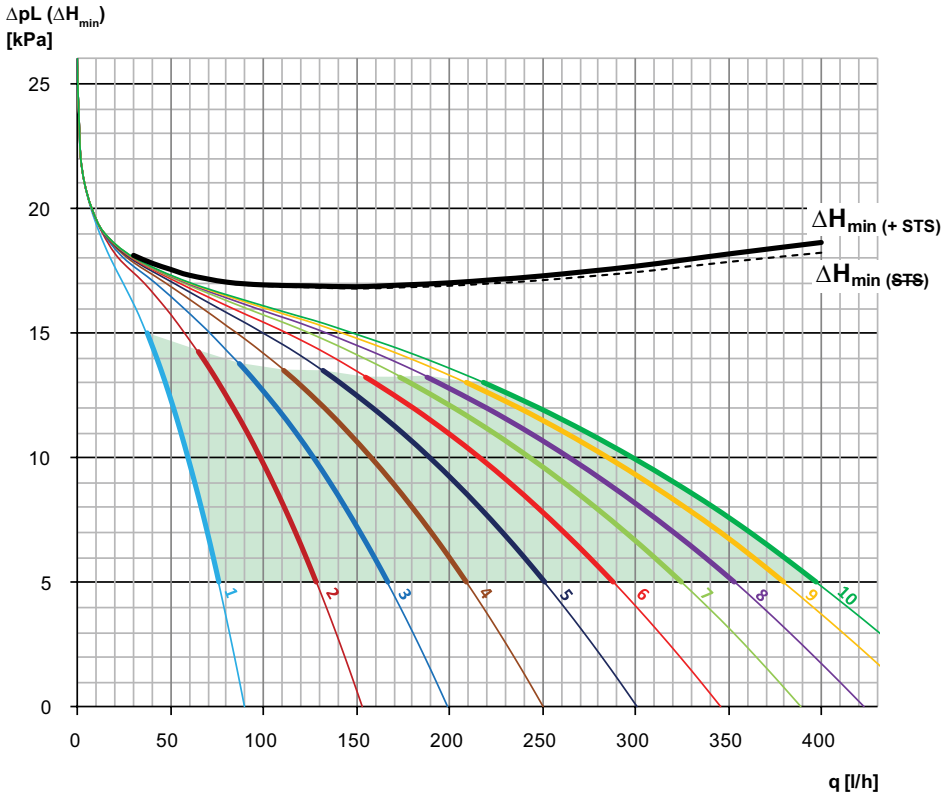

DN 20

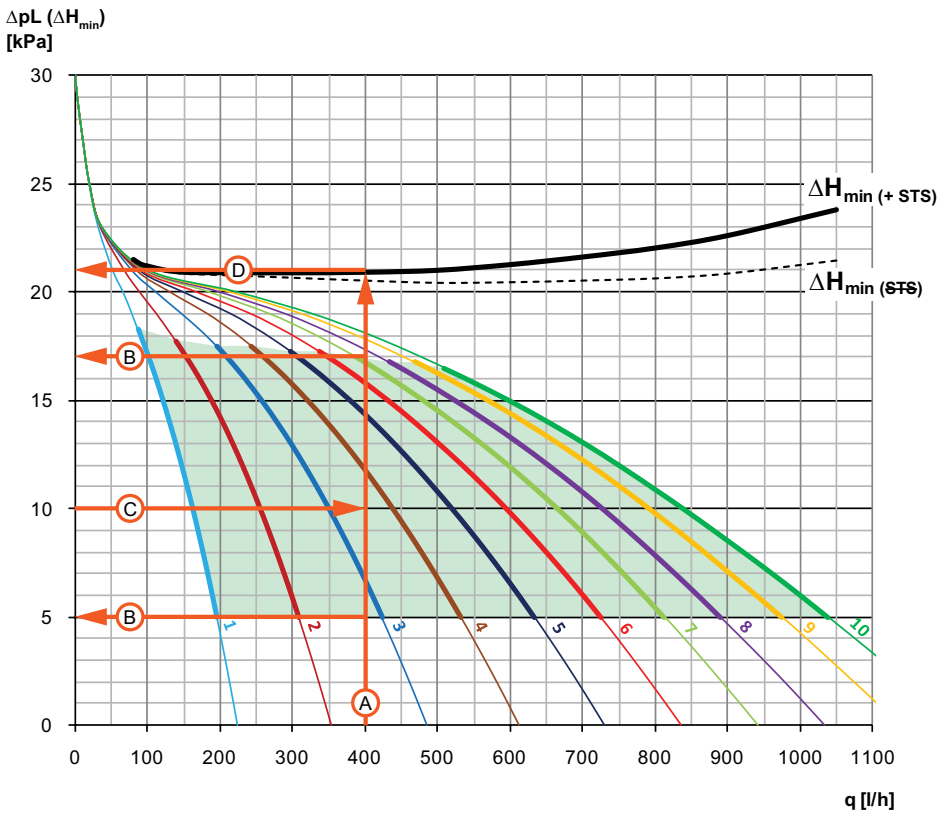

Example - DN 20

Design flow 400 l/h and ΔpL 10 kPa.

- A.** Draw a straight vertical line from the required flow up to the black curve.
- B.** This line crosses the green area for recommended setting range of ΔpL , in this case 5-17 kPa.
- C.** Draw a straight horizontal line from the chosen ΔpL , this line cross the vertical line A in the setting point. If this setting point is in between two setting curves, then estimate the setting, in this case 3,6.
- D.** Draw a horizontal line from where the vertical line A mate the ΔH_{min} curve to the scale and read the ΔH_{min} , in this case 21 kPa (including the ΔpV of STS, dashed curve excluding ΔpV of STS).

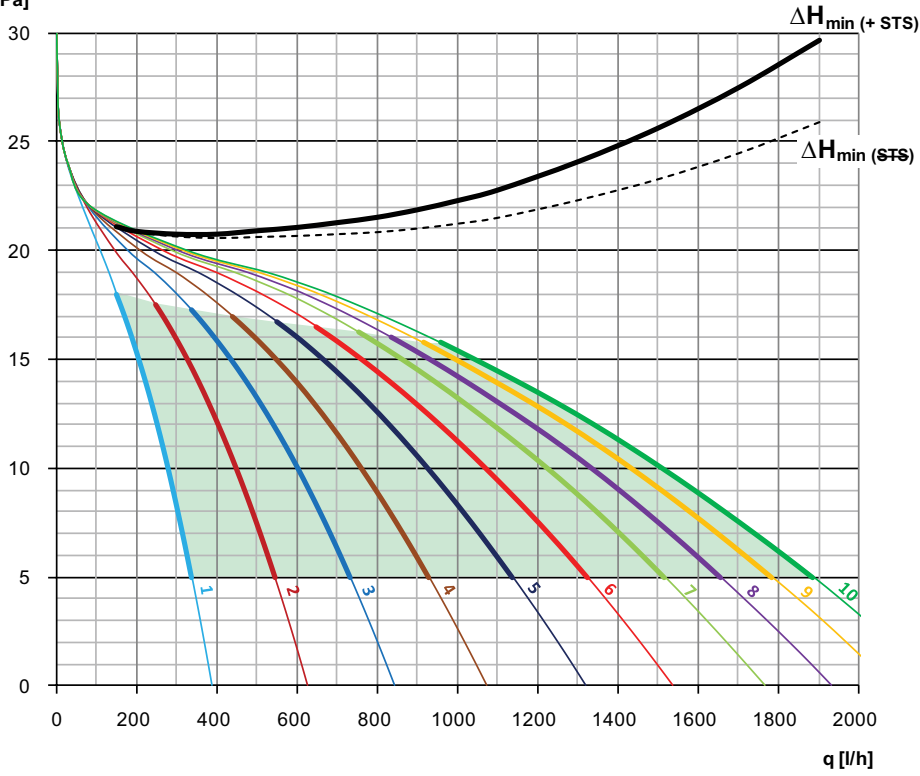
DN 25
 $\Delta p_L (\Delta H_{min})$
 [kPa]

Installation

Application example

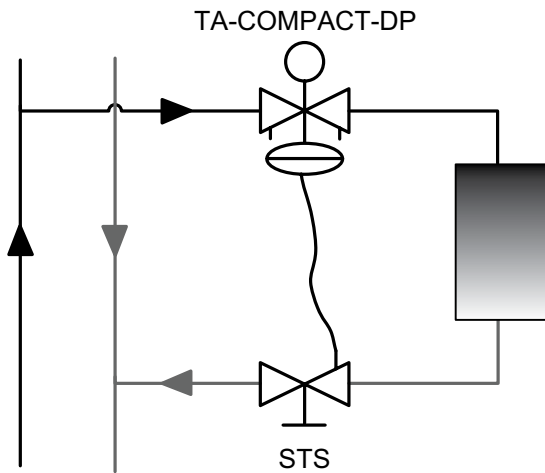

Note: The TA-COMPACT-DP must be installed before the load (inlet pipe) and the capillary pipe must be connected before the shut-off valve (STS) to enable isolation during system maintenance, see "Shut-off" under "Operating function".

Flow direction

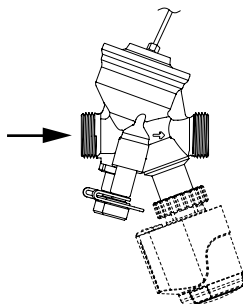

Note: For proper function capillary pipe and membrane chamber must be deaerated, see "Venting" under "Operating function".

Installation of capillary pipe and actuator EMO T

Approx. 15 mm of free space is required above the actuator. Space above membrane chamber min. 20 mm to avoid interruption on capillary pipe.

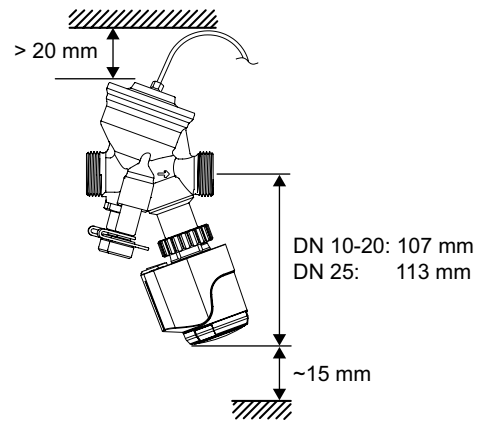

TA-COMPACT-DP + EMO T

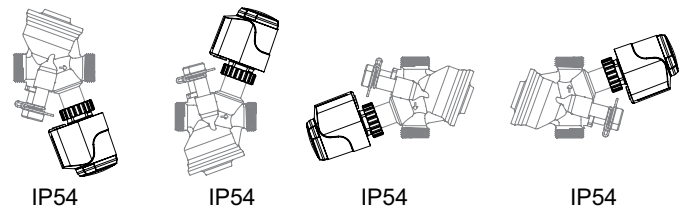

Operating function

Setting

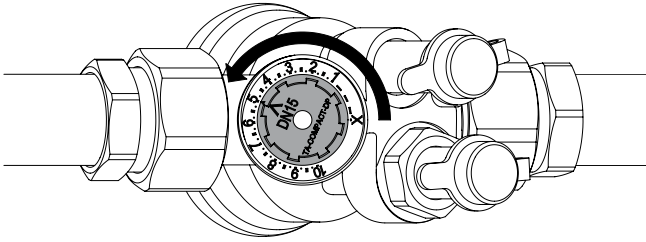

1. Turn the setting wheel to desired value, e.g. 5.0.

Measuring q

1. Remove the installed actuator.
2. Connect the IMI TA balancing instrument to the measuring points.
3. Input the valve type, size and setting and the actual flow is displayed.

Measuring ΔH

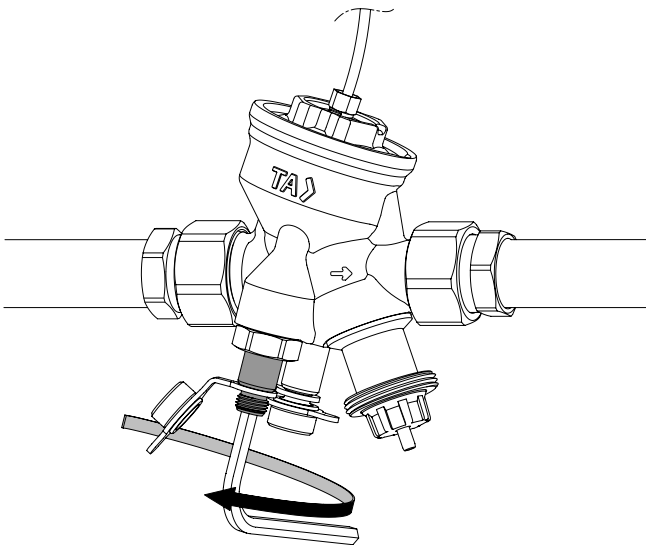

1. Remove any actuator.
2. Close the valve according to "Shut-off".
3. Bypass the Δp -part by opening the bypass spindle ≈ 1 turn anticlockwise, with a 5 mm Allen key.
4. Connect IMI TA balancing instrument to the measuring points and measure.

Important! Reopen the valve to previous setting and close the bypass spindle after the measurement is completed.

Venting

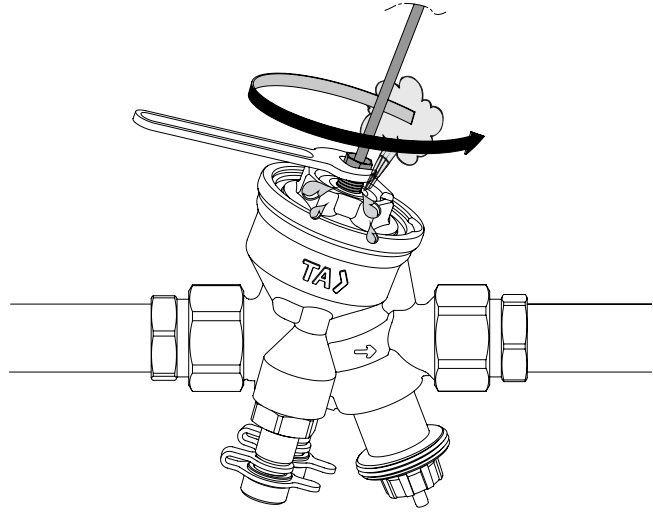

1. To vent the capillary pipe and the membrane chamber, loosen the capillary pipe ~ 1 turn.

Shut-off

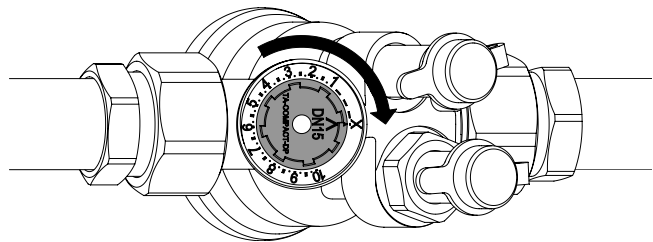

1. Turn the setting wheel clockwise to X.

Articles

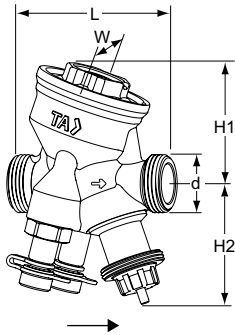

External thread

Threads according to ISO 228
1 m capillary pipe included.

DN	d	L	H1	H2	W	Kg	EAN	Article No
10	G1/2	74	55	55	54	0,57	7318794040205	52 164-210
15	G3/4	74	55	55	54	0,60	7318794025608	52 164-215
20	G1	85	64	55	64	0,75	7318794025707	52 164-220
25	G1 1/4	93	64	61	64	0,90	7318794025806	52 164-225

*) Connection to actuator.
→ = Flow direction

Connections

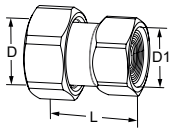

With internal thread

Threads according to ISO 228. Thread length according to ISO 7-1.
Swivelling nut
Brass

Valve DN	D	D1	L*	EAN	Article No
10	G1/2	G3/8	29,5	5902276820014	52 009-810
10	G1/2	G1/2	34,5	5902276820021	52 009-910
15	G3/4	G1/2	31,5	5902276820038	52 009-815
15	G3/4	G3/4	36,5	5902276820045	52 009-915
20	G1	G3/4	33,5	5902276820052	52 009-820
20	G1	G1	39,5	5902276820069	52 009-920
25	G1 1/4	G1	39	5902276820076	52 009-825
25	G1 1/4	G1 1/4	43	5902276820083	52 009-925

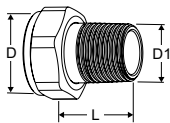

With external thread

Threads according to ISO 7-1.
Swivelling nut
Brass

Valve DN	D	D1	L*	EAN	Article No
10	-	-	-	-	-
15	G3/4	R1/2	29	4024052516612	0601-02.350
20	G1	R3/4	32,5	4024052516810	0601-03.350
25	G1 1/4	R1	35	4024052517015	0601-04.350

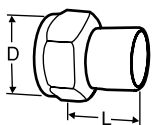

Welding connection

Swivelling nut
Brass/Steel 1.0045 (EN 10025-2)

Valve DN	D	Pipe DN	L*	EAN	Article No
10	G1/2	10	30	7318792748400	52 009-010
15	G3/4	15	36	7318792748509	52 009-015
20	G1	20	40	7318792748608	52 009-020
25	G1 1/4	25	40	7318792748707	52 009-025

*) Fitting length (from the gasket surface to the end of the connection).

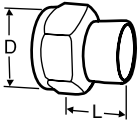
Soldering connection

Swivelling nut

Brass/gunmetal CC491K (EN 1982)

Valve DN	D	Pipe Ø	L*	EAN	Article No
10	G1/2	10	10	7318792749100	52 009-510
10	G1/2	12	11	7318792749209	52 009-512
15	G3/4	15	13	7318792749308	52 009-515
15	G3/4	16	13	7318792749407	52 009-516
20	G1	18	15	7318792749506	52 009-518
20	G1	22	18	7318792749605	52 009-522
25	G1 1/4	28	21	7318792749704	52 009-528

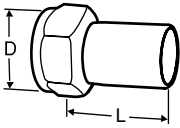

Connection with smooth end

For connection with press coupling

Swivelling nut

Brass/AMETAL®

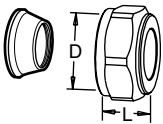
Valve DN	D	Pipe Ø	L*	EAN	Article No
10	G1/2	12	35	7318793810502	52 009-312
15	G3/4	15	39	7318793810601	52 009-315
20	G1	18	44	7318793810700	52 009-318
20	G1	22	48	7318793810809	52 009-322
25	G1 1/4	28	53	7318793810908	52 009-328

Compression connection

Support bushes shall be used, for more information see catalogue leaflet FPL.

Should not be used with PEX pipes.

Brass/AMETAL®

Chrome plated

Valve DN	D	Pipe Ø	L**	EAN	Article No
10	G1/2	8	16	7318793620002	53 319-208
10	G1/2	10	17	7318793620101	53 319-210
10	G1/2	12	17	7318793620200	53 319-212
10	G1/2	15	20	7318793620309	53 319-215
10	G1/2	16	25	7318793620408	53 319-216
15	G3/4	15	27	7318793705006	53 319-615
15	G3/4	18	27	7318793705105	53 319-618
15	G3/4	22	27	7318793705204	53 319-622

*) Fitting length (from the gasket surface to the end of the connection).

**) Over all length L refers to unassembled coupling.

Accessories

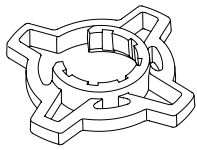

Grip for setting wheel, optional

For better grip when presetting.
For TA-COMPACT-P/-DP and
TA-Modulator (DN 10-32).

Colour	EAN	Article No
Orange	7318794040502	52 164-950

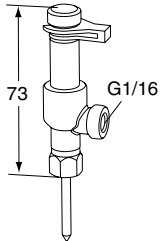

Measuring point, two-way

For connection of capillary pipe while
permitting simultaneous use of our
balancing instrument.

EAN	Article No
7318793784100	52 179-200

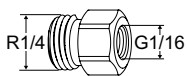

Transition nipple

For capillary pipe with G1/16 connection.

EAN	Article No
R1/4xG1/16	7318794025509

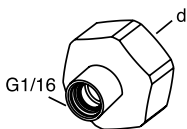

Transition nipple

For capillary pipe with G1/16 connection.
For connection to IMI TA valves with
drain.

d	EAN	Article No
G1/2	7318793660206	52 179-981
G3/4	7318793660305	52 179-986

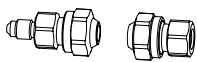

Extension kit for capillary pipe

Complete with connections for 6 mm
pipe

EAN	Article No
7318793781505	52 265-212

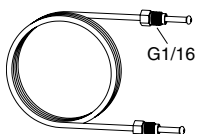

Capillary pipe

1 pc included in TA-COMPACT-DP.

L	EAN	Article No
1 m	7318793661500	52 265-301

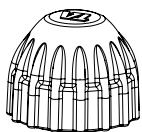

Protection cap

For TA-COMPACT-P/-DP, TA-Modulator
(DN 10-20), TBV-C/-CM.

EAN	Article No
Red	7318793961105

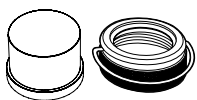

Tamper proof cover

Set containing plastic cover and locking
ring for valves with connection M30x1,5
to thermostatic head/actuator.
Prevents manipulation of setting.

EAN	Article No
7318794030206	52 164-100

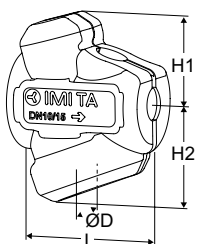

Insulation

For heating/comfort cooling.
Material: EPP.
Fire class: E (EN 13501-1), B2 (DIN 4102).
The insulation must be manually
adjusted for the capillary pipe.

Valve DN	L	H1	H2	D	EAN	Article No
10-15	100	61	71	84	7318794027404	52 164-901
20	118	67	79	90	7318794027503	52 164-902
25	127	71	84	104	7318794027602	52 164-903

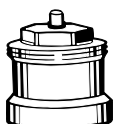

Spindle extension

Recommended together with the
insulation to minimize the risk of
condensation at the valve-actuator
interface. M30x1,5.

L	EAN	Article No
Plastic, black		
30	4024052165018	2002-30.700

Additional equipment

For shut-off and connection of capillary pipe in the return pipe use STS + transition nipple 52 179-981/-986.

For more information on STS - see separate catalogue leaflet under section "Expert System Components".

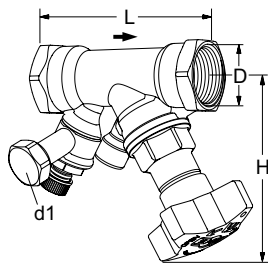

STS

With drain

Internal threads.

Thread according to ISO 228. Thread length according to ISO 7/1.

DN	D	L	H	Kvs	Kg	EAN	Article No
d1 = G3/4							
15*	G1/2	84	100	3,5	0,60	5902276896569	52 849-615
20*	G3/4	94	100	6,8	0,66	5902276896576	52 849-620
25	G1	105	105	9,8	0,86	5902276896583	52 849-625
d1 = G1/2							
15*	G1/2	84	100	3,5	0,60	5902276896507	52 849-215
20*	G3/4	94	100	6,8	0,66	5902276896514	52 849-220
25	G1	105	105	9,8	0,86	5902276896521	52 849-225

→ = Flow direction

Kvs = m³/h at a pressure drop of 1 bar and fully open valve.

*) Can be connected to smooth pipes by KOMBI compression coupling.

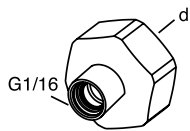

Transition nipple

For capillary pipe with G1/16 connection.

For connection to IMI TA valves with drain.

d	EAN	Article No
G1/2	7318793660206	52 179-981
G3/4	7318793660305	52 179-986

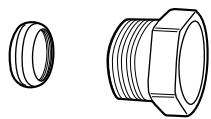

KOMBI compression coupling

Max.: 100°C

(For more information see catalogue leaflet KOMBI.)

Male pipe threads on thrust screw	For pipes, diameter	EAN	Article No
G1/2	10	7318792874901	53 235-109
G1/2	12	7318792875007	53 235-111
G1/2	14	7318792875106	53 235-112
G1/2	15	7318792875205	53 235-113
G1/2	16	7318792875304	53 235-114
G3/4	15	7318792875403	53 235-117
G3/4	18	7318792875601	53 235-121
G3/4	22	7318792875700	53 235-123