

Climate
Control

IMI Pneumatex

Simply Compresso



Pressure maintenance systems with compressors

For heating systems up to 400 kW and cooling systems up to 600 kW

Simply Compresso

Simply Compresso is a precision pressurisation system with a compressor and integrated expansion vessels for heating, solar and chilled water systems. Especially suitable in situations where extreme compactness, plug&play installation and full pressure control are required. Simply Compresso is the latest addition to the Compresso Connect series intended for 4 bar safety valve installations up to 400 kW in heating capacity. The **BrainCube Connect** control panel ensures a new level of connectivity, enabling communication with the BMS system and other BrainCubes, as well as remote operation of the pressurisation system through live viewing.



Key features

Improved design for easier and more comfortable operation

Resistant 3.5" TFT illuminated colour touch display. Intuitive and user friendly menu. Web based interface with remote control and live view. BrainCube Connect control panel integrated into TecBox.

Plug & Play installation and start-up

Getting the Simply Compresso up and running only takes three easy steps.

Pressure maintenance with ECO-night mode

Keeping compressor runtime to the absolute minimum.

State-of-the-Art Connectivity

Standard connections (RS485, Ethernet, USB) to BMS and remote devices, saving time during commissioning and maintenance, and allowing for control of the unit.

Technical description – Control unit TecBox

Applications:

Heating, solar and chilled water systems. For systems according to EN 12828, SWKI HE301-01, solar systems according to EN 12976, ENV 12977 with on-site temperature cutoff protection in case of a power outage.

Pressure:

Min. admissible pressure, PS_{min} : 0 bar
 Max. admissible pressure, PS : 4 bar
 Min. operating pressure, dpu_{min} : 0,5 bar
 Max. operating pressure, dpu_{max} : 3,5 bar

Temperature:

Max. admissible temperature, t_{Smax} : 70°C
 Min. admissible temperature, t_{Smin} : 5°C

Ambient temperature:

Max. admissible ambient temperature, t_{Amax} : 40°C
 Min. admissible ambient temperature, t_{Amin} : 5°C

Accuracy:

Precision pressure maintenance $\pm 0,1$ bar.

Supply voltage:

1 x 230V (-6% + 10%) / 50/60 Hz

Electric load:

See Articles.

Enclosure class:

IP 22 according to EN 60529

Sound pressure level:

59 dB(A) / 1bar

Mechanical connections:

System connection S: G1/2"
 Water make-up inlet Swm: G3/4"

Material:

Main materials include steel, brass, and bronze.

Transportation and storage:

In frostless, dry places.

Standard:

Constructed according to MD 2006/42/EC, Annex II 1.A
 EMC-D. 2014/30/EU

Expansion vessel

Primary vessel included in TecBox. For more information see Technical description - Expansion vessels.

Technical description – Expansion vessels

Applications:

Primary vessel is part of the Control unit TecBox. Optional extension vessel only with Control unit TecBox. See Applications under Technical description - Control unit TecBox.

Media:

Non-aggressive and non-toxic system media.
Ethylene or propylene glycol-based antifreeze up to 50%.

Pressure:

Min. admissible pressure, PSmin: 0 bar
Max. admissible pressure, PS: 4 bar

Temperature:

Max. admissible bag temperature, t_{Bmax} : 70°C
Min. admissible bag temperature, t_{Bmin} : 5°C

For PED purposes:

Max. admissible temperature, t_{Smax} : 120°C
Min. admissible temperature, t_{Smin} : -10°C

Material:

Steel. Color beryllium.
Airproof butyl bag according to EN 13831.

Transportation and storage:

In frostless, dry places.

Standard:

Constructed according to PED 2014/68/EU.

Warranty:

Compresso CD, CD...E: 5-year warranty for the vessel.

Function, Equipment, Features

Plug & Play installation and start-up

Thanks to an integrated primary expansion vessel featuring a pre-calibrated level sensor, the improved start-up procedure is as easy as follows:

- Connect unit to the installation
- Plug in power supply
- Follow the instructions displayed on the BrainCube

Control unit BrainCube Connect

- Intelligent, fully automatic, and safe system operation. Self-optimisation with memory function.
- Resistive 3.5" TFT illuminated colour touch display. User-friendly, operation-oriented, multilingual interface with slide and tap navigation, step-by-step start up guide, and direct help in pop-up windows. Plain text and/or graphic representation of all relevant parameters and status information.
- Data logging and system analysis, chronological message memory with prioritisation, remote control with live view, automatic self test.
- Primary vessel ready assembled and integrated as part of the control unit.

Water make-up (Simply Compresso 4 C2.1-80 SWM)

- Fillsafe: water-make up monitoring and control with integrated contact water flow meter and solenoid valve.
- Connection for optional Pleno P BA4R water make-up device for tap water protection following EN 1717.
- Softsafe monitoring and control for optional refill water treatment device.

Pressure maintenance

- Precision pressure maintenance ± 0.1 bar
- ECO-night mode with programmable timer to help keep compressor runtime to the absolute minimum by using the available hysteresis between the maximum initial and the final system pressure at night. Before reaching the "night time" the system pressure will be adjusted to the max. value.
- Silent-run compressor

Expansion vessels

- Airproof butyl bag.
- Including assembly kit for the air-side connection of the vessels and lock shield valve for the water-side connection with ball valve for fast draining (CD...E).
- Condensate drain at the bottom.
- Ready assembled as part of the TecBox (primary vessel CD).

Calculation

Pressure maintenance for systems TAZ ≤ 100°C

Calculation following EN 12828, SWKI HE301-01 *).

For all special applications such as solar systems, district heating systems, systems with temperatures above 100 °C or cooling systems with temperatures below 5 °C please use HySelect software or contact us.

General equations

Vs	Water capacity of the system	Heating	$Vs = vs \cdot Q$	vs Q	Specific water capacity, table 4. Installed heat capacity
			Vs= Known		System design, content calculation
		Cooling	Vs= Known		System design, content calculation
Ve	Expansion volume	EN 12828	$Ve = e \cdot (Vs + Vhs)$	e, ehs	Expansion coefficient for $t_{s,max}$, table 1
		Cooling	$Ve = e \cdot (Vs + Vhs)$	e, ehs	Expansion coefficient for $t_{s,max}$, table 1 ⁷⁾
		SWKI HE301-01 heating	$Ve = e \cdot Vs \cdot X^{(1)} + ehs \cdot Vhs$	e ehs	Expansion coefficient for $(t_{s,max} + tr) / 2$, table 1 Expansion coefficient for $t_{s,max}$, table 1
		SWKI HE301-01 cooling	$Ve = e \cdot Vs \cdot X^{(1)} + ehs \cdot Vhs$	e, ehs	Expansion coefficient for $t_{s,max}$, table 1 ⁷⁾
Vwr	Water reserve	EN 12828, Cooling	$Vwr \geq 0,005 \cdot Vs \geq 3 L$		
		SWKI HE301-01	Vwr is considered in Ve with the coefficient X		
p0	Minimum pressure ²⁾ Lower limit value for the pressure maintenance	EN 12828, Cooling	$p0 = Hst/10 + 0,2 \text{ bar} \geq pz$	Hst	Static height Minimum required equipment pressure for pumps or boilers
		SWKI HE301-01	$p0 = Hst/10 + 0,3 \text{ bar} \geq pz$	pz	
pa	Initial pressure Lower threshold for an optimum pressure maintenance		$pa \geq p0 + 0,3 \text{ bar}$		
pe	Final pressure Upper threshold for an optimum pressure maintenance.			psvs dpsvs _c	Response pressure safety valve system Closing pressure tolerance of the safety valve
		EN 12828	$pe \leq psvs - dpsvs_c$	dpsvs _c dpsvs _c	= 0,5 bar for psvs ≤ 5 bar ⁴⁾ = 0,1 · psvs for psvs > 5 bar ⁴⁾
		cooling	$pe \leq psvs - dpsvs_c$	dpsvs _c dpsvs _c	= 0,6 bar for psvs ≤ 3 bar ⁴⁾ = 0,2 · psvs for psvs > 3 bar ⁴⁾
		SWKI HE301-01 heating	$pe \leq psvs/1,15$ and $pe \leq psvs - 0,3 \text{ bar}$		psvs ⁴⁾
SWKI HE301-01 cooling, solar, heat pumps	$pe \leq psvs/1,3$ and $pe \leq psvs - 0,6 \text{ bar}$		psvs ⁴⁾		

Compresso

pe	Final pressure		$pe = pa + 0,2$		
VN	Nominal volume of the expansion vessel ⁵⁾	EN 12828, Cooling	$VN \geq (Ve + Vwr + 2^3) \cdot 1,1$		
		SWKI HE301-01	$VN \geq (Ve + 2^3) \cdot 1,1$		
TecBox			$Q = f(Hst)$		>> Quick selection Compresso

1) Heating, Cooling, Solar: $Q \leq 10 \text{ kW}$: $X = 3$ | $10 \text{ kW} < Q \leq 150 \text{ kW}$: $X = (87 - 0,3 \cdot Q) / 28$ | $Q > 150 \text{ kW}$: $X = 1,5$

Geothermal probe systems: $X = 2,5$

2) The formula for minimum pressure p0 applies to the installation of pressure maintenance on the suction side of the circulation pump. In case of a pressure-side installation p0 is to be increased by the pump pressure Δp.

3) Add 2 litres when a Vento is installed in the system.

4) Safety valves must operate within these limits. Use component-tested and certified safety valves of type H and DGH for heating systems, type F and DGF for cooling, and type SOL and DGF for solar. For systems according to SWKI HE301-01, only safety valves of the approval type DGF and DGH may be used.

5) Please select a vessel with an equal or higher nominal volume.

7) Max. system standstill temperature, usually 40°C for cooling applications and geothermal probes with ground regeneration, 20°C for other geothermal probes

*) SWKI HE301-01: Valid for Switzerland

HySelect calculation software is based on an advanced calculation method and database. Results may vary.

Table 1: e expansion coefficient

t (TAZ, t _{Smax} , tr, t _{Smin}), °C	20	30	40	50	60	70	80	90	100	105	110
e Water = 0 °C	0,0016	0,0041	0,0077	0,0119	0,0169	0,0226	0,0288	0,0357	0,0433	0,0472	0,0513
e % weight MEG*											
30 % = -14,5 °C	0,0093	0,0129	0,0169	0,0224	0,0286	0,0352	0,0422	0,0497	0,0577	0,0620	0,0663
40 % = -23,9 °C	0,0144	0,0189	0,0240	0,0300	0,0363	0,0432	0,0505	0,0582	0,0663	0,0706	0,0750
50 % = -35,6 °C	0,0198	0,0251	0,0307	0,0370	0,0437	0,0507	0,0581	0,0660	0,0742	0,0786	0,0830
e % weight MPG**											
30 % = -12,9 °C	0,0151	0,0207	0,0267	0,0333	0,0401	0,0476	0,0554	0,0639	0,0727	0,0774	0,0823
40 % = -20,9 °C	0,0211	0,0272	0,0338	0,0408	0,0481	0,0561	0,0644	0,0731	0,0826	0,0873	0,0924
50 % = -33,2 °C	0,0288	0,0355	0,0425	0,0500	0,0577	0,0660	0,0747	0,0839	0,0935	0,0985	0,1036

Table 4: vs approx. water capacity *** of central heatings referred to the installed heat capacity Q

ts _{max} tr	°C	90 70	80 60	70 55	70 50	60 40	50 40	40 30	35 28
Radiators	vs liter/kW	14,0	16,5	20,1	20,6	27,9	36,6	-	-
Flat radiators	vs liter/kW	9,0	10,1	12,1	11,9	15,1	20,1	-	-
Convectors	vs liter/kW	6,5	7,0	8,4	7,9	9,6	13,4	-	-
Air handlers	vs liter/kW	5,8	6,1	7,2	6,6	7,6	10,8	-	-
Floor heating	vs liter/kW	10,3	11,4	13,3	13,1	15,8	20,3	29,1	37,8

*) MEG = Mono-Ethylene Glycol

**) MPG = Mono-Propylene Glycol

***) Water capacity = heat generator + distribution net + heat emitters

Table 5: DNe standard values for expansion pipes with Simply Compresso

Length up to approx. 30 m	DNe	20	25
Heating:			
EN 12828	Q kW	1000	1700
SWKI HE301-01 *)	Q kW	300	600
Cooling:			
t _{Smax} ≤ 50 °C	Q kW	1600	2700

*) Valid for Switzerland

Temperatures

t_{Smax}	Maximum system temperature Maximum temperature for the calculation of the volume expansion. For heating systems the dimensioned flow temperature at which a heating system is to be operated with the lowest outside temperature to be assumed (standard outside temperature according to EN 12828). For cooling systems the max. temperature that is achieved due to the operation mode or standstill, for solar systems the temperature up to which an evaporation is to be avoided.
t_{Smin}	Lowest system temperature Lowest temperature for calculating expansion volumes. The lowest system temperature is equal to the freezing point. It is dependant on the percentage of antifreeze additives. For water without additives t _{Smin} = 0.
tr	Return temperature Return temperature of the heating system with the lowest outside temperature to be assumed (standard outside temperature according to EN 12828).
TAZ	Safety temperature limiter Safety temperature controller Temperature limit Safety device according to EN 12828 for the temperature protection of heat generators. If the set temperature limit is exceeded the heating is turned off. Limiters are locked, controllers automatically release the heat supply if the set temperature falls short. Setting value for systems according to EN 12828 ≤ 110 °C.

Precision pressure maintenance

Air controlled Compresso minimize the pressure variations between p_a and p_e .
 $\pm 0,1$ bar

ECO-night operation

Special mode for pressure maintenance to keep compressor runtime to the absolute minimum by using the available hysteresis between maximum initial and final system pressure
 $p_{\min} < p < p_{\max}$

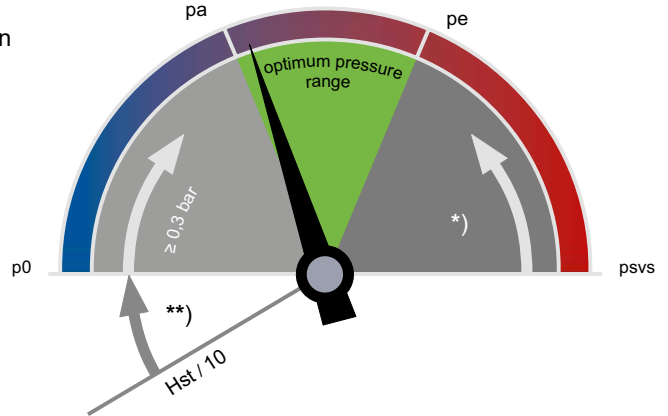

**)

EN 12828, Solar, Cooling: $\geq 0,2$ bar
 SWKI HE301-01: $\geq 0,3$ bar

*)

EN 12828: $\geq psvs \cdot 0,1 \geq 0,5$ bar
 Solar, Cooling: $\geq psvs \cdot 0,2 \geq 0,6$ bar
 SWKI HE301-01 Heating: $\geq psvs \cdot (1-1/1,15) \geq 0,3$ bar
 SWKI HE301-01 Cooling, Solar, Heat Pumps: $\geq psvs \cdot (1-1/1,3) \geq 0,6$ bar

p0 Minimum pressure

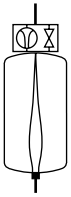

Compresso

p_0 and the switching points are calculated by the BrainCube.

pa Initial pressure

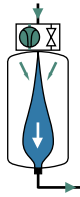

Compresso

If the system pressure is $< p_a$, the compressor starts.
 $p_a = p_0 + 0,3$

pe Final pressure

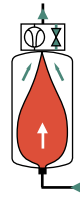

Compresso

If system pressure is $> p_e$ the air relief valve opens.
 $p_e = p_a + 0,2$

Quick selection

Heating systems TAZ ≤ 100°C, without addition of antifreeze

Q [kW]	Static height Hst / m	TecBox and extension vessel				
		Radiators		Flat radiators		Floor heating
		70 50	50 40	70 50	50 40	35 28
Nominal volume VN [liter]						
EN12828						
< 100	28	C2.1-80	C2.1-80	C2.1-80	C2.1-80	C2.1-80
150	28	C2.1-80 + CD 80E	C2.1-80 + CD 80E	C2.1-80	C2.1-80 + CD 80E	C2.1-80 + CD 80E
200	28	C2.1-80 + CD 80E	C2.1-80 + CD 80E	C2.1-80	C2.1-80 + CD 80E	C2.1-80 + CD 80E
250	26	C2.1-80 + CD 80E	-	C2.1-80 + CD 80E	C2.1-80 + CD 80E	C2.1-80 + CD 80E
300	23	-	-	C2.1-80 + CD 80E	-	-
350	20	-	-	C2.1-80 + CD 80E	-	-
400	17	-	-	C2.1-80 + CD 80E	-	-
SWKI HE301-01						
< 100	27	C2.1-80	C2.1-80	C2.1-80	C2.1-80	C2.1-80
150	27	C2.1-80 + CD 80E	C2.1-80 + CD 80E	C2.1-80	C2.1-80	C2.1-80
200	27	C2.1-80 + CD 80E	C2.1-80 + CD 80E	C2.1-80	C2.1-80	C2.1-80 + CD 80E
250	25	C2.1-80 + CD 80E	C2.1-80 + CD 80E	C2.1-80 + CD 80E	C2.1-80 + CD 80E	C2.1-80 + CD 80E
300	22	-	-	C2.1-80 + CD 80E	C2.1-80 + CD 80E	C2.1-80 + CD 80E
350	19	-	-	C2.1-80 + CD 80E	C2.1-80 + CD 80E	-
400	16	-	-	C2.1-80 + CD 80E	C2.1-80 + CD 80E	-

Examples

Example EN 12828

Q = 200 kW
 Flat radiators 50 | 40 °C
 Hst = 25 m
 psvs = 4,0 bar

Selected:
 TecBox C2.1-80 S
 Extension vessel: CD 80E

Check safety valve psvs and static height Hst:
 for TAZ = 100 °C
 EN 12828:

- Hst: 25 < 27 ⇒ o.k.
- psvs: $25/10 + 0,7 + 0,5 = 3,7 \leq 4,0$ ⇒ o.k.

Example SWKI HE301-01

Q = 200 kW
 Flat radiators 50 | 40 °C
 Hst = 25 m
 psvs = 4,0 bar

Selected:
 TecBox C2.1-80 S
 Extension vessel: not necessary

Check safety valve psvs and static height Hst:
 for TAZ = 100 °C
 SWKI HE301-01:

- Hst: 25 < 27 ⇒ o.k.
- psvs: $(25/10 + 0,8) \cdot 1,15 = 3,795 \leq 4,0$ ⇒ o.k.

Equipment

Expansion pipes

According to table 5.

Lock shield valve DLV

Included with delivery.

Zeparo

Air vent Zeparo ZUT or ZUP at each high point for venting while filling and/or draining. Separator for dirt and magnetite in each system in the main return to the heat generator. If no central degassing (Vento V Connect) is installed a microbubble separator can be added in the main flow, before the circulation pump where possible. The static height (Hst_m per the following table) above the microbubble separators must not be exceeded.

ts _{max} °C	90	80	70	60	50	40	30	20	10
Hst _m mWs	15,0	13,4	11,7	10,0	8,4	6,7	5,0	3,3	1,7

Application examples

Simply Compresso 4 C2.1-80 S

TecBox with one compressor and primary vessel, precision pressure maintenance $\pm 0,1$ bar.

For heating systems without water make-up

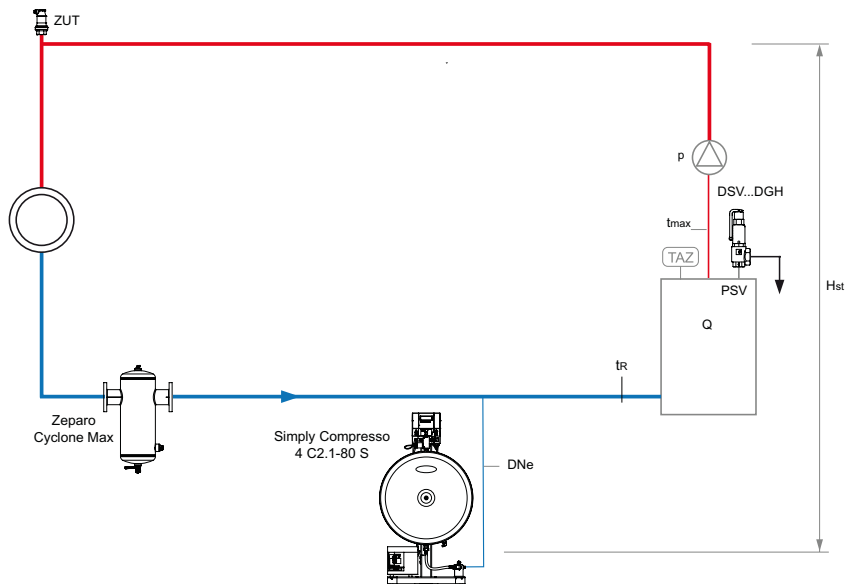

Simply Compresso 4 C2.1-80 SWM

TecBox with one compressor and primary vessel, precision pressure maintenance $\pm 0,1$ bar, Pleno P BA4R for water make-up and Pleno Refill for water treatment.

For heating systems with water make-up

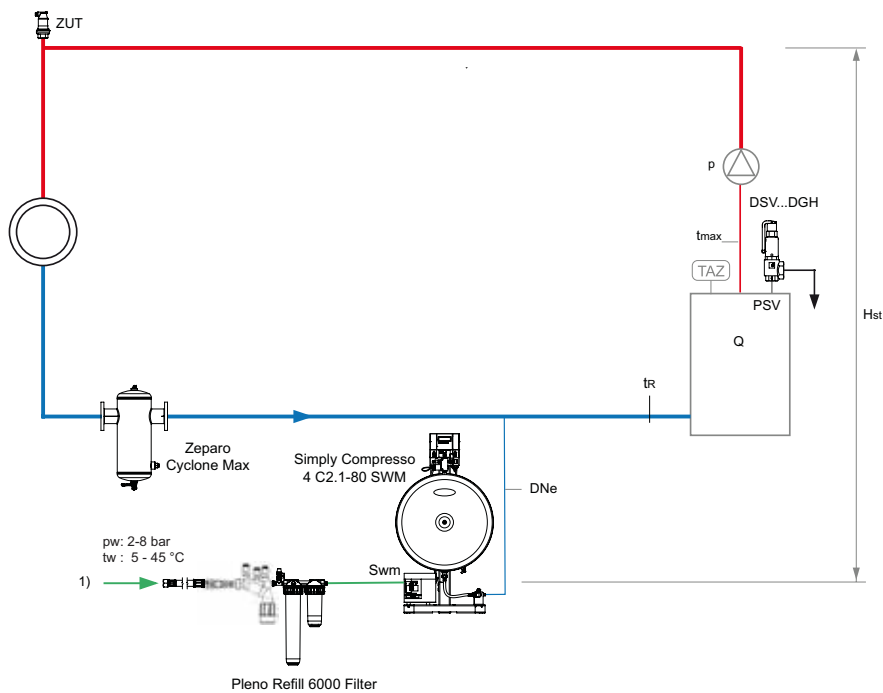

1) Water make-up connection, $p_w \geq p_0 + 1,7$ bar (max. 8 bar)

Zeparo Cyclone Max cyclonic dirt separator with magnet ZCXM in the return.

Zeparo ZUT for automatic venting while filling and/or draining.

Further accessories, product and selection details, see: Datasheet Pleno, Zeparo and Accessories.

Installation

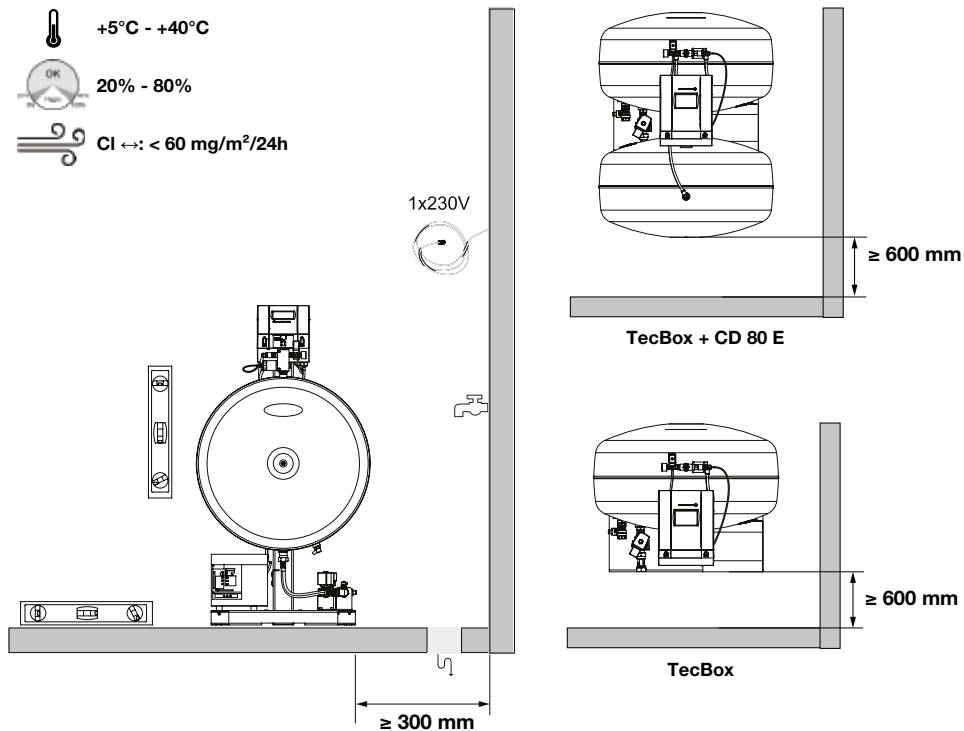

Control unit TecBox, Simply Compresso 4 C2.1-80

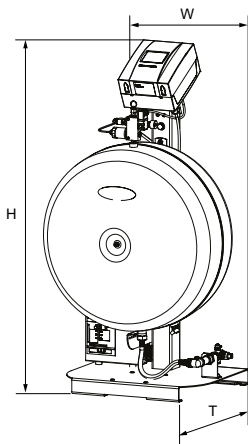

Simply Compresso 4 C2.1-80 S

Precision pressure maintenance ± 0.1 bar, ECO-night functionality.
 1 compressor, 1 spill valve, 1 primary vessel.

Type	PS [bar]	max dpu [bar]	VN [l]	B	H	T	m [kg]	PeI [kW]	EAN	Article No
C2.1-80 S	4	3,5	80	603	1107	481	39	0,3	7640161645837	301021-41011

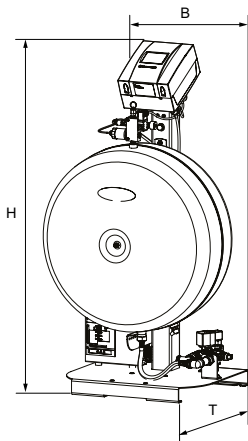

Simply Compresso 4 C2.1-80 SWM

Precision pressure maintenance ± 0.1 bar, ECO-night functionality.
 1 compressor, 1 spill valve, 1 primary vessel.

1 water meter and 1 solenoid valve for water make-up.

Type	PS [bar]	max. dpu [bar]	VN [l]	B	H	T	m [kg]	PeI [kW]	EAN	Article No
C2.1-80 SWM	4	3,5	80	603	1107	481	41	0,3	7640161645844	301021-41012

VN = Nominal volume

Extension vessels

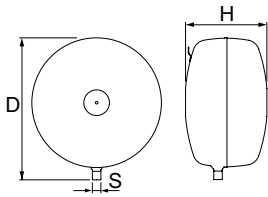

Compresso CD...E

Secondary vessel. Including flex tube for the water-side with Simply Compresso TecBox, assembly kit for the air-side connection with Simply Compresso TecBox.

Type	VN [l]	D	H	m [kg]	S	EAN	Article No
4 bar (PS)							
CD 80.4 E	80	636	346 **)	16	R3/4	7640161637450	301021-41003

VN = Nominal volume

**) Tolerance 0 /+35

Water make-up protection module

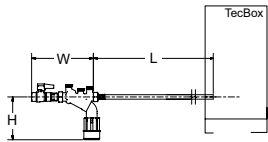

Pleno P BA4 R

Hydraulic unit for water make-up operation with Vento/Transfero Connect, Pleno PX/PIX, Simply Compresso 4 C2.1-80 SWM, and in combination with Pleno Refill modules. Features a shut off valve, check valve, filter and a type BA backflow preventer (protection class 4) according to EN 1717. Connection (Swm): G1/2

Type	PS [bar]	B	L	H	m [kg]	qwm [l/h]	EAN	Article No
BA4 R	10	210	1300	135	1,1	350 *	7640161630147	813 3310
						250 **		
						50 ***		
						q(pw-pout) ****		

qwm = make-up water flow

* maximum average value for make-up water degassing with Vento V/VI and Transfero TV/TVI

** maximum average value for make-up water degassing with Vento Compact

*** when using flow limiter for operation with low flow water treatment cartridges

**** for combination with Pleno PX/PIX see q(pw-pout) diagram in Pleno Connect datasheet

Pleno Refill 6000, 12000 / Pleno Refill Demin 2000, 4000

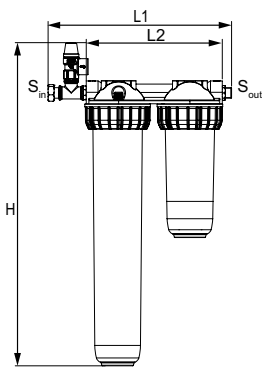

Pleno Refill

Hydraulic unit for water softening together with Vento/Transfero Connect TecBoxes. Filter with 25 µm mesh size to protect the hydronic system. Softening bottle filled with high grade resin. Designed for plug&play mounting together with Transfero/Vento Connect.

Units for all applications including Transfero Connect and Vento Connect with the use of a flow throttle that is included with each Transfero/Vento Connect.

Softening unit with wall mounting bracket and 25 µm filter

3/4" swivelling nut, 3/4" external thread suitable for flat gasket, with flow limiter.

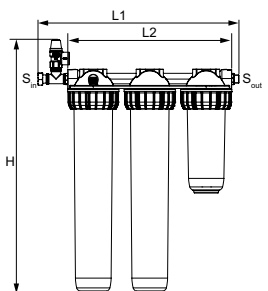

Type	Capacity l x °dH	S _{in}	S _{out}	H	L1	L2	m [kg]	EAN	Article No
Refill 6000 filter	6000	G3/4	G3/4	644	366	271	4,6	7640153570864	813 3010
Refill 12000 filter	12000	G3/4	G3/4	644	513	420	8,3	7640161631946	813 3011

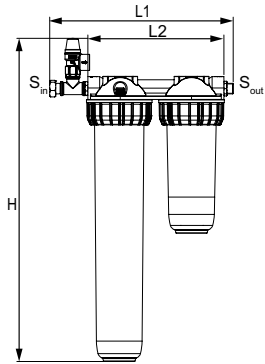

Demineralisation unit with wall mounting bracket and 25 µm filter

3/4" swivelling nut, 3/4" external thread suitable for flat gasket, with flow limiter. In compliance with SWKI-BT-102-1.

Type	Capacity l x °dH	S _{in}	S _{out}	H	L1	L2	m [kg]	EAN	Article No
Refill Demin 2000 filter	2000	G3/4	G3/4	644	366	271	4,6		813 3015
Refill Demin 4000 filter	4000	G3/4	G3/4	644	513	420	8,3		813 3016

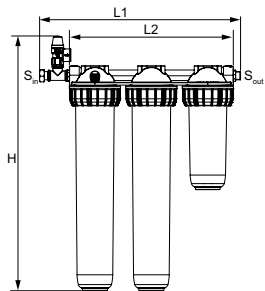

Wiring diagrams

230 V / 50/60 Hz

Power Supply Compresso C.1

Used / connected:
 Line : Netz / alimentation / voltage
 P/C1 : Kompressor / compresseur / compressor
 V1 : Überströmventil / Vanne de décharge / Spill valve
 WM : Nachspeiseventil / Vanne d'appoint d'eau / Water make up valve
 OD1-OD3 : Meldungen / messages / messages

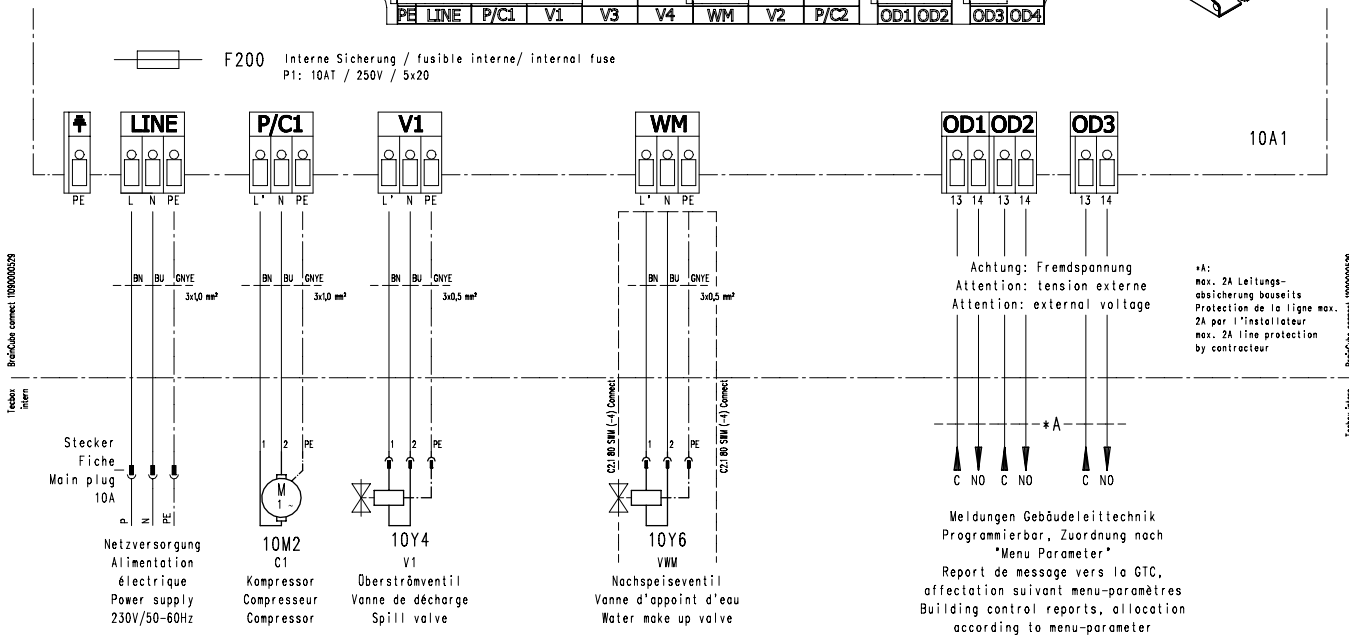
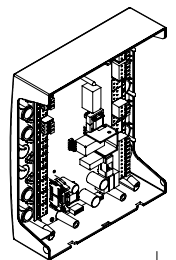
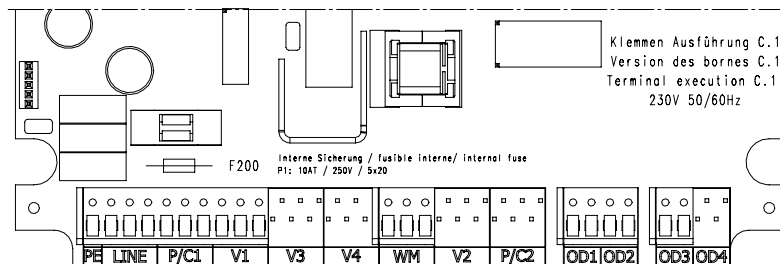

Safety Extra Low Voltage connections

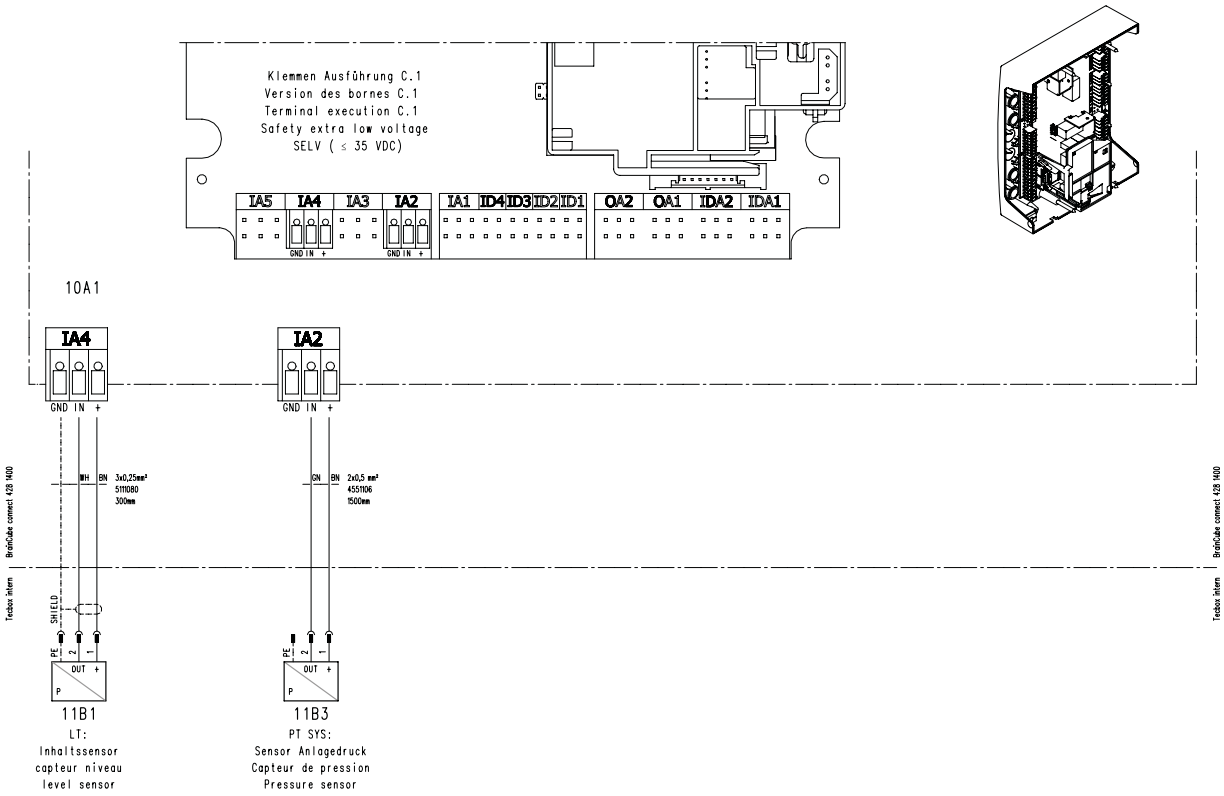

Communication

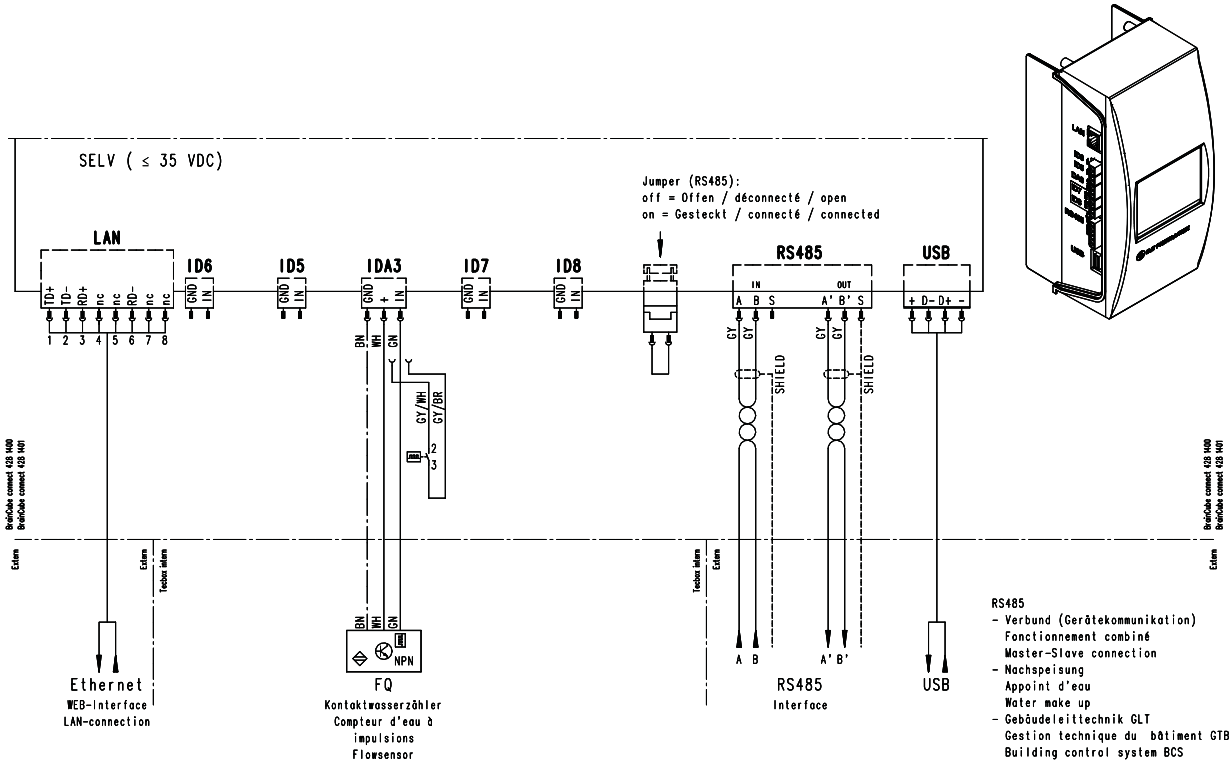

The products, texts, photographs, graphics and diagrams in this document may be subject to alteration by IMI without prior notice or reasons being given. For the most up to date information about our products and specifications, please visit www.climatecontrol.imiplc.com.